



WE MAGNETISE THE WORLD



## Classic Line

Single-Stroke Solenoids for Industrial Applications



INDUSTRIAL MAGNETIC SYSTEMS

BINDER

## We develop solutions!

Kendrion develops, manufactures and markets high-quality electromagnetic and mechatronic systems and components for industrial and automotive applications. For over a century we have been engineering precision parts for the world's leading innovators in passenger cars, commercial vehicles and industrial applications.

As a leading technology pioneer, Kendrion invents, designs and manufactures complex components and customised systems as well as local solutions on demand. Committed to the engineering challenges of tomorrow, taking responsibility for how we source, manufacture and conduct business is embedded into our culture of innovation. Rooted in Germany and headquartered in the Netherlands, our expertise extends across Europe to the Americas and Asia. Created with passion and engineered with precision.

In the business unit **Industrial Magnetic Systems (IMS)** the focus lies on electromagnetic actuators and mechatronic assemblies for applications in power engineering, safety engineering, machine building, automation technology and other industries. With the experience of our traditional brands Binder, Neue Hahn Magnet and Thoma Magnettechnik we are successful in our markets as an industry expert with a high technological competence.

We offer you both customer-specific and standardised products. Our assemblies are based on powerful and reliable single-stroke, holding, locking, spreader, control, rotary, vibratory solenoids and solenoid valves.

**We always think in terms of solutions.**

Our strength lies in new developments for our customers. Our engineers are specialists for innovative products with optimum technical properties. Furthermore, we develop mechanical assemblies, modern drive electronics and sensor systems to your requirements.

Our products are manufactured in Germany at the parent companies Donaueschingen and Engelswies as well as in the USA, China and Romania. This ensures efficient project management and a needs-oriented delivery for our internationally operating customers.

By means of segmented production areas we can implement both small quantities and large series with an optimum degree of automation.

We guarantee top quality.

All products are tested and developed in compliance with the norm DIN VDE 0580 for electromagnetic devices and components or according to industry-specific standards of our customers. In many cases our products are tested and certified by external associations. among others according to the CSA, VdS and ATEX guidelines. Our quality management system is certified according to DIN EN ISO 9001. and our environmental management system fulfils the norm ISO 14001.

With our subsidiaries in Switzerland, Austria, Italy, the USA and China and our worldwide distribution network we are your ideal partner on site.

**Kendrion – We magnetise the world**

[www.kendrion.com](http://www.kendrion.com)

# Classic Line

**Linear solenoids of the Kendrion Classic Line** are universal and cost-effective actuating solenoids ideally suited for use in industrial applications.

## **Advantages**

These solenoids are used in the transportation industry, automation engineering and materials handling. Particular advantages are the individual mounting options, the maintenance-free armature bearing and the compact design.

## **Functionality**

The mode of operation of the solenoid is based on the force exerted on ferromagnetic bodies in the magnetic field. Electromagnets transform electric energy into mechanical kinetic energy.

Basically, the stroke movement takes place from the stroke starting position to the stroke stop position (active direction of movement), while the armature reset is accomplished by external forces, e.g. by spring, weight or magnetic forces (passive direction of movement).

The solenoids can be installed in any position, but the force transfer should be in axial direction only. The power indicated is reached at 90% of the rated voltage and in warmed-up condition. The values for the duty cycles are reference values and apply for rated voltage, warmed-up condition and load with 70% of the magnetic force of the device.

All products are manufactured and tested according to DIN VDE 0580/07.2000 and comply with RoHS.

Design subject to change.

The solenoids listed here show the product variety of this product line. A large number of them are standardized products. Minimum order quantities and different duty cycles are available upon request.



### **Direct acting solenoids**

*D-Frame Solenoids*

*C-Frame Solenoids*

### **Monostable direct acting solenoids**



## Product Overview

### Direct acting solenoids

D-Frame Solenoids

Page 6 - 13

C-Frame Solenoids

Page 14 - 18



### Direct acting solenoids

With DC-direct acting solenoids the stroke movement is achieved by electromagnetic force from the stroke starting position to the stroke stop position. The armature reset is realized by external forces. Depending on the direction of the force output of the armature the distinction between pulling and pushing design is made. DC-direct acting solenoids can be used on either side.

#### Designs and Models

As described below the different frame solenoids can be divided into the two standards designs “D-frame” and “C-frame”.



*D-Frame Solenoids are linear solenoids (single-stroke solenoids) which form a shape comparable to the letter D, i.e. a closed frame.*



*C-Frame Solenoids are linear solenoids (single-stroke solenoids) which form a shape comparable to the letter C, i.e. an open frame.*

## Monostable direct acting solenoid

Page 19 - 20

Accessories

Page 21 - 23

Technical Explanations

Page 24 - 25



## Monostable direct acting solenoid

The single-stroke solenoid in monostable design equipped with a permanent magnet keeps the armature currentless in stroke stop position.

The magnetic field is neutralized by negative coil energization and the armature can be reset to stroke starting position by external forces.

### Benefits

Energy savings, safety in case of power failure, reduced dimensions, weight and cost savings as well as almost constant magnetic forces allow for a variety of applications in office machine and apparatus engineering, in automation, in textile machines, in control systems and in automobile manufacturing.

## Direct acting solenoid LCL-D

The **D-Frame Solenoids** of the type series LCL meet high standards in terms of performance and life expectancy.

Compact dimensions and low power consumption, fast switching times and smooth operation characterise this series. The housing is made of precision steel tube. The armature is guided in highly wear-resistant maintenance-free precision bearings on both sides, resulting in consistent solenoid performance throughout the long service life.

Parts at risk of corrosion are electro-galvanized.

The armature is chemically nickel-plated.

Either lateral or front mounting via threaded holes is possible.

### Accessories

- Fork head (Page 23)
- Plug-in connector (Page 22)
- Optimization of control by micro power controllers on request.

### Model

- Connection by connector plug - Protection class IP65
- Lead wires - Protection class IP00
- Standard rated voltage = 24 V DC / 205 V DC
- Standard duty cycle = 100% ED

### LCL-D Standard

The coil is supplied **encapsulated with plastics** as standard.

Accessories: Return spring can be used (Page 21)

Model: Device - Protection class IP40  
Insulation class „B“ - 130°C

### Excels by

**Compact design**

**Pushing & pulling application**

**Maintenance-free use**



### LCL-D with bellow

The coil is supplied **encapsulated** as standard

Accessories: Return spring **can not** be used

Model: Device - Protection class IP54  
Insulation class „B“ - 130°C

### Excels by

**Higher protection class**



LCL-D Standard

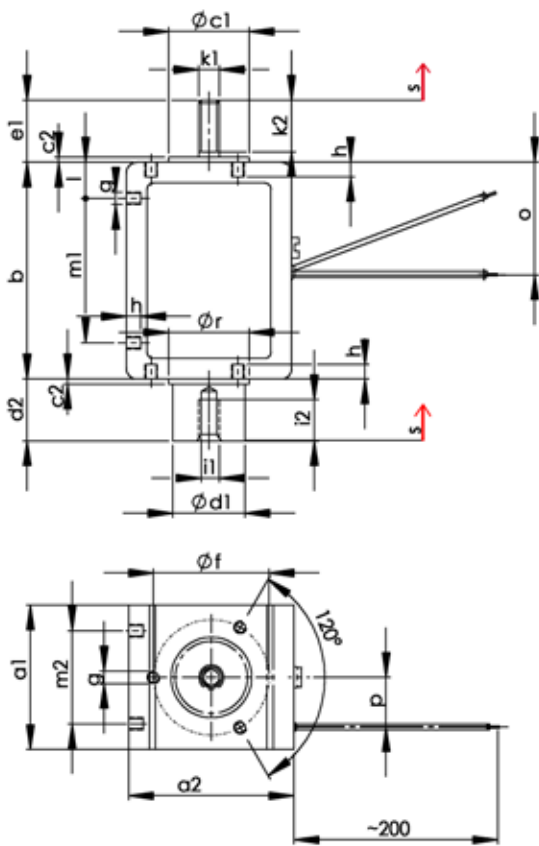

Armature position shown in currentless condition

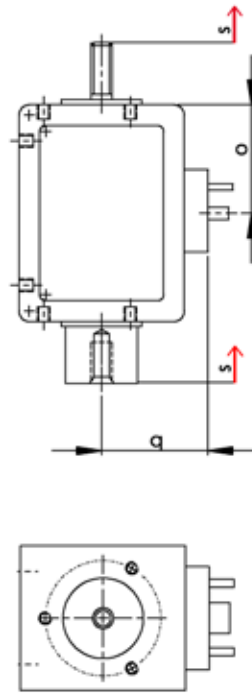

LCL-D with bellow

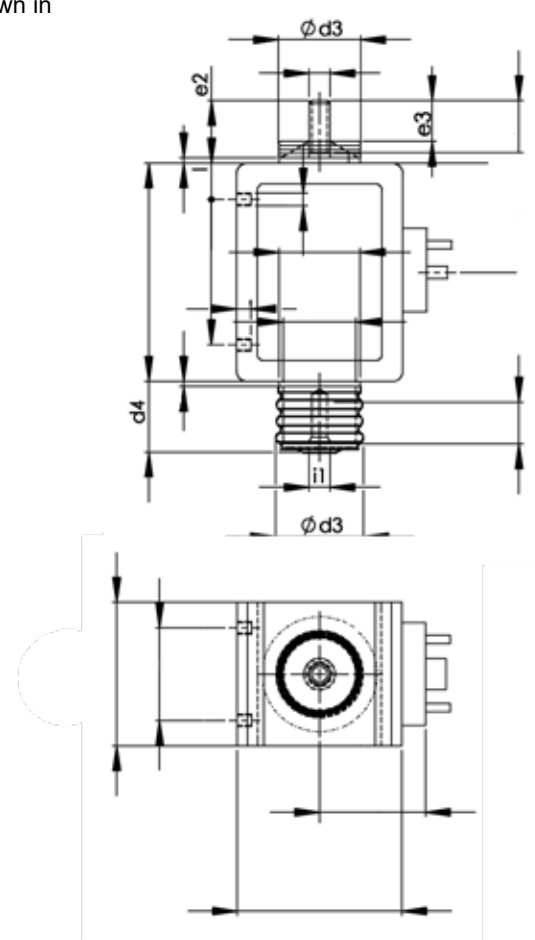

Dimensions in mm

Designation	s	a1	a2	b	c1	c2	d1	d2	*d3	*d4	e1	*e2	*e3	f	g	h	i1	i2	k1	k2	l	m1	m2	o	p	q	r
LCL030035	5	30	35	45	17	2.5	15	8	26.5	14	25	29	10	24	M3	3.5	M4	8	M4	10	10	25	22	22.5	9	27	17
* with bellow	10							13		19	20	24															
	15							18		24	15	19															
LCL040050	5	40	50	65	23	2.5	20	8	34	19	35	42	17	34	M4	5	M6	14	M6	15	12.5	40	30	32.5	9	34.5	23
*with bellow	10							13		24	30	37															
	15							18		29	25	32															
	20							23		34	20	27															
LCL048060	5	48	60	75	28	2.5	25	8	40	18	45	56	20	40	M4	6	M8	15	M8	20	15	45	38	37.5	9	39.5	28
*with bellow	10							13		23	40	51															
	15							18		28	35	46															
	25							28		38	25	36															
LCL060070	5	60	70	90	34	2.5	30	8	46	27	45	62	20	48	M5	6.5	M8	15	M8	20	15	60	48	45	9	44.5	34
*with bellow	10							13		32	40	57															
	15							18		37	35	52															
	25							28		47	25	42															
LCL070080	5	70	80	105	39	2.5	35	8	53	30	55	75	25	56	M6	7	M10	22	M10	25	17.5	70	55	52.5	9	49.5	39
*with bellow	10							13		35	50	70															
	15							18		40	45	65															
	20							23		45	40	60															
	30							33		55	30	50															

## Technical Data

Designation	LCL030035											
Duty cycle [%]	100			40			25			5		
Stroke [mm]	<b>5</b>	<b>10</b>	<b>15</b>	<b>5</b>	<b>10</b>	<b>15</b>	<b>5</b>	<b>10</b>	<b>15</b>	<b>5</b>	<b>10</b>	<b>15</b>
Response time [ms]	61	68	75	53	59	65	41	45	50	24	27	30
Release time [ms]	28	32	35	24	27	30	20	23	25	16	18	20
Rated power [W]	10.5			18			26.5			100		
Armature weight [kg] *	0.055 (0.06)			0.055 (0.06)			0.055 (0.06)			0.055 (0.06)		
Solenoid weight [kg] *	0.25 (0.3)			0.25 (0.3)			0.25 (0.3)			0.25 (0.3)		
Insulation class	B			B			B			B		

\* Value in brackets: (LCL with bellow)

Designation	LCL040050															
Duty cycle [%]	100				40				25				5			
Stroke [mm]	<b>5</b>	<b>10</b>	<b>15</b>	<b>20</b>	<b>5</b>	<b>10</b>	<b>15</b>	<b>20</b>	<b>5</b>	<b>10</b>	<b>15</b>	<b>20</b>	<b>5</b>	<b>10</b>	<b>15</b>	<b>20</b>
Response time [ms]	98	109	122	135	66	73	81	90	51	57	63	70	33	36	41	45
Release time [ms]	33	36	41	45	29	32	36	40	24	27	30	33	18	20	23	25
Rated power [W]	18				38				57				234			
Armature weight [kg] *	0.125 (0.15)				0.125 (0.15)				0.125 (0.15)				0.125 (0.15)			
Solenoid weight [kg] *	0.66 (0.79)				0.66 (0.79)				0.66 (0.79)				0.66 (0.79)			
Insulation class	B				B				B				B			

\* Value in brackets: (LCL with bellow)

Designation	LCL048060A															
Duty cycle [%]	100				40				25				5			
Stroke [mm]	<b>5</b>	<b>10</b>	<b>15</b>	<b>25</b>	<b>5</b>	<b>10</b>	<b>15</b>	<b>25</b>	<b>5</b>	<b>10</b>	<b>15</b>	<b>25</b>	<b>5</b>	<b>10</b>	<b>15</b>	<b>25</b>
Response time [ms]	144	160	178	220	92	102	113	140	62	69	77	95	33	37	41	50
Release time [ms]	36	40	45	55	33	36	40	50	26	29	32	40	20	22	24	30
Rated power [W]	22				45				75				308			
Armature weight [kg] *	0.23 (0.26)				0.23 (0.26)				0.23 (0.26)				0.23 (0.26)			
Solenoid weight [kg] *	1.16 (1.28)				1.16 (1.28)				1.16 (1.28)				1.16 (1.28)			
Insulation class	B				B				B				B			

\* Value in brackets: (LCL with bellow)

Designation	LCL060070															
Duty cycle [%]	100				40				25				5			
Stroke [mm]	<b>5</b>	<b>10</b>	<b>15</b>	<b>25</b>	<b>5</b>	<b>10</b>	<b>15</b>	<b>25</b>	<b>5</b>	<b>10</b>	<b>15</b>	<b>25</b>	<b>5</b>	<b>10</b>	<b>15</b>	<b>25</b>
Response time [ms]	230	255	284	350	138	153	170	210	86	95	105	130	36	40	45	55
Release time [ms]	44	49	54	67	41	45	50	62	31	35	39	48	24	26	29	36
Rated power [W]	28				65				98				470			
Armature weight [kg] *	0.41 (0.50)				0.41 (0.50)				0.41 (0.50)				0.41 (0.50)			
Solenoid weight [kg] *	2.04 (2.50)				2.04 (2.50)				2.04 (2.50)				2.04 (2.50)			
Insulation class	B				B				B				B			

\* Value in brackets: (LCL with bellow)

Designation	LCL070080																			
Duty cycle [%]	100					40					25					5				
Stroke [mm]	<b>5</b>	<b>10</b>	<b>15</b>	<b>20</b>	<b>30</b>	<b>5</b>	<b>10</b>	<b>15</b>	<b>20</b>	<b>30</b>	<b>5</b>	<b>10</b>	<b>15</b>	<b>20</b>	<b>30</b>	<b>5</b>	<b>10</b>	<b>15</b>	<b>20</b>	<b>30</b>
Response time [ms]	266	295	328	365	450	186	207	230	255	315	103	115	128	142	175	35	39	44	49	60
Release time [ms]	48	53	59	66	81	47	52	58	65	80	34	38	42	47	58	25	28	31	35	43
Rated power [W]	39					95					150					680				
Armature weight [kg] *	0.63 (0.77)					0.63 (0.77)					0.63 (0.77)					0.63 (0.77)				
Solenoid weight [kg] *	3.25 (3.40)					3.25 (3.40)					3.25 (3.40)					3.25 (3.40)				
Insulation class	B					B					B					B				

\* Value in brackets: (LCL with bellow)



## Stroke Force Curves

LCL030035 (43 11...03D00/D50)

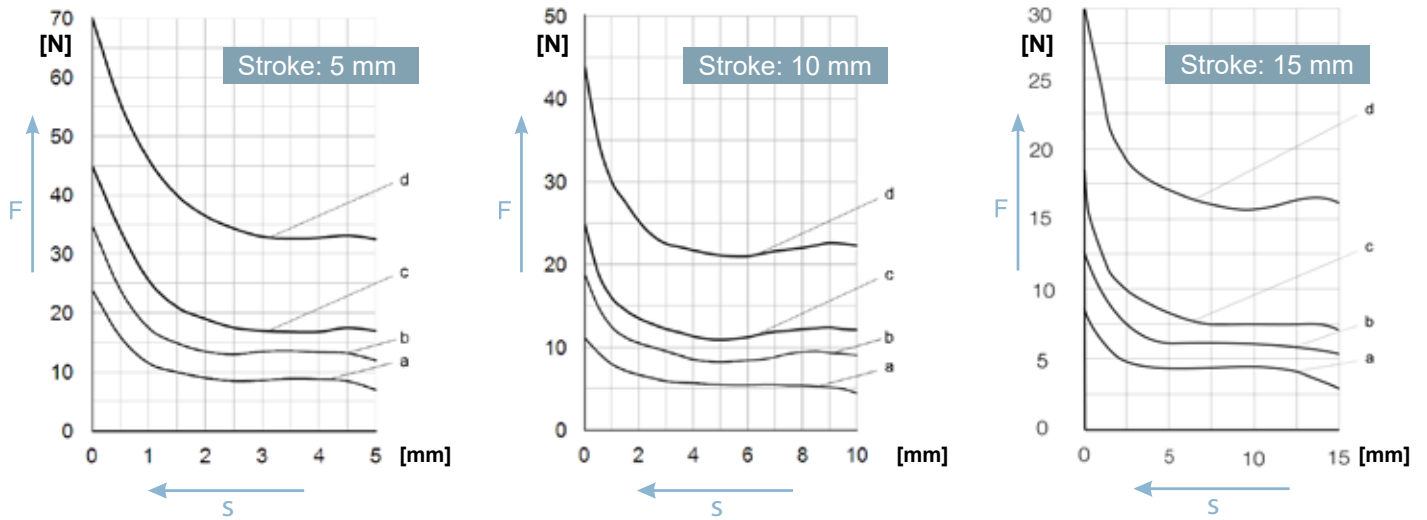

Duty cycle: a = 100% b = 40% c = 25% d = 5% Values in brackets = old designation

LCL040050A00 (43 11...04E00/E50)

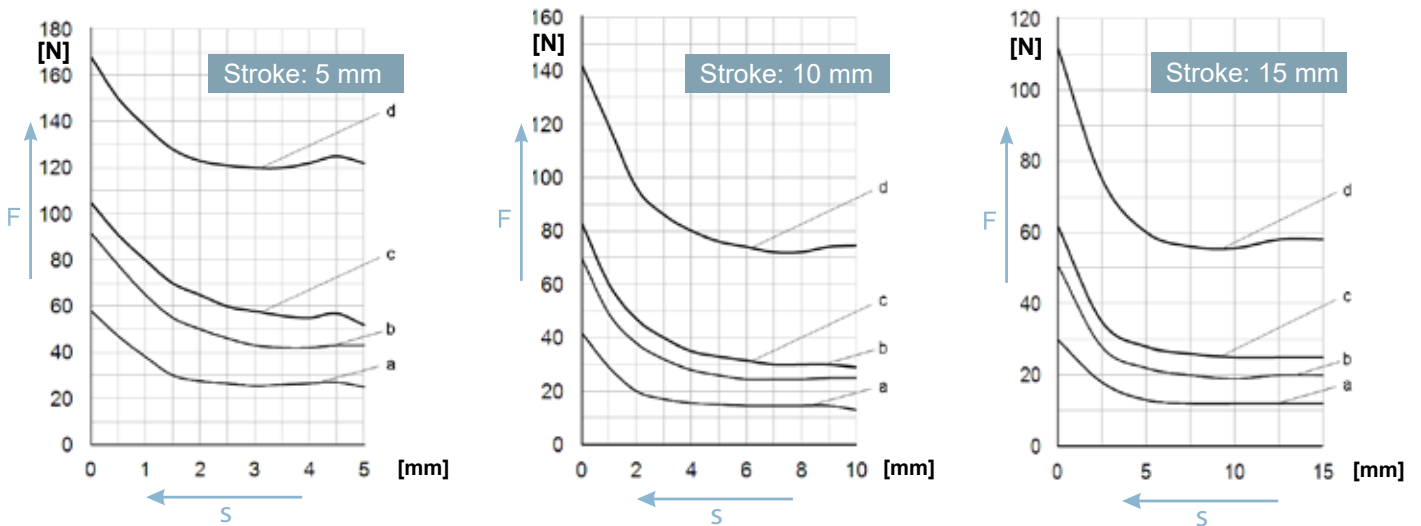

LCL040050A00 (43 11...04E00/EE50)

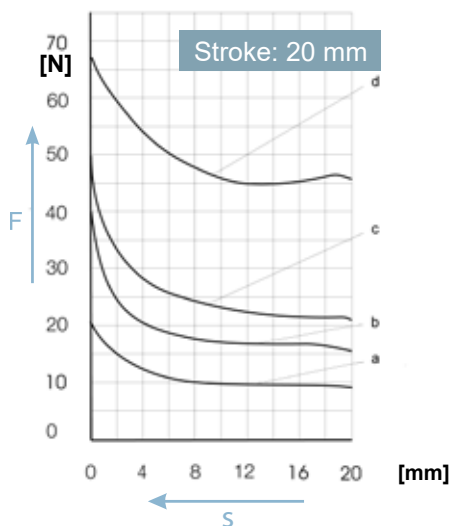

Duty cycle: a = 100% b = 40% c = 25% d = 5% Values in brackets = old designation

# Stroke Force Curves

LCL048060 (43 11...05D00/D50)

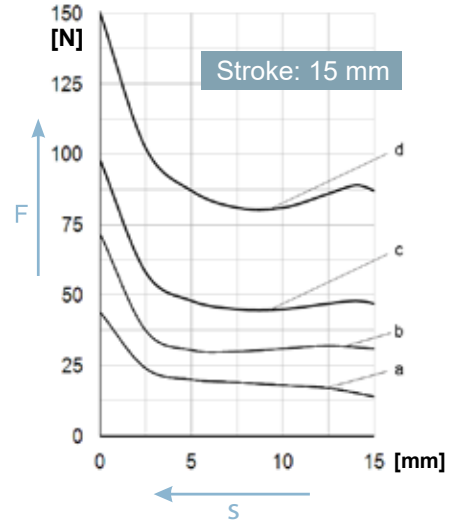
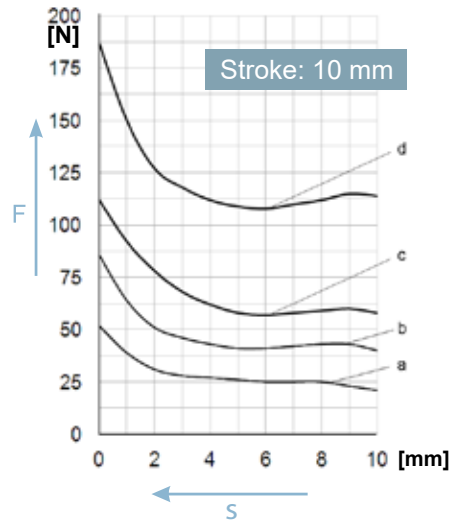
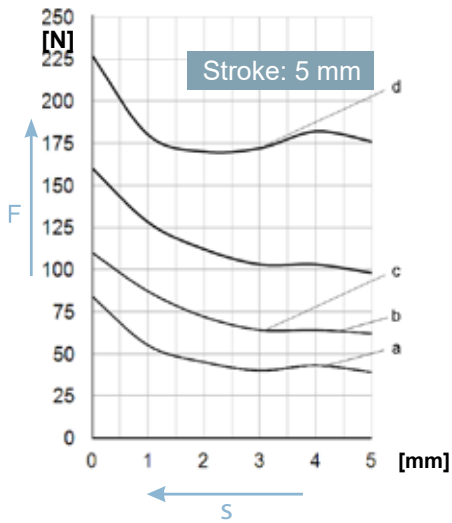

Duty cycle: a = 100% b = 40% c = 25% d = 5% Values in brackets = old designation

LCL048060 (43 11...05D00/D50)

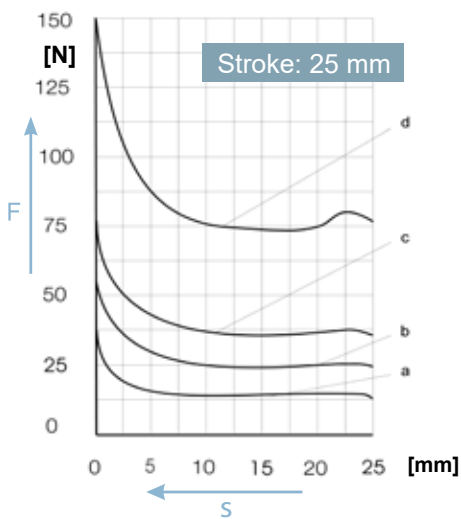

LCL060070 (43 11...06D00/D50)

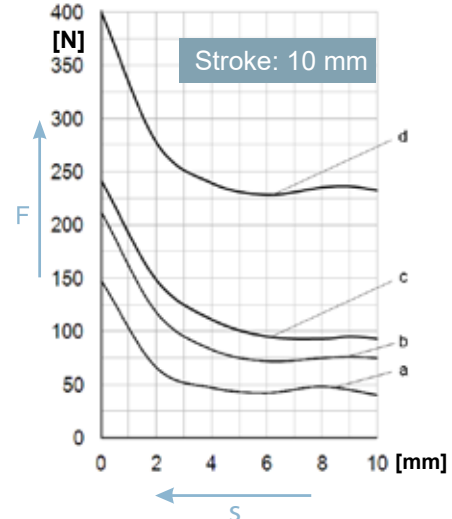
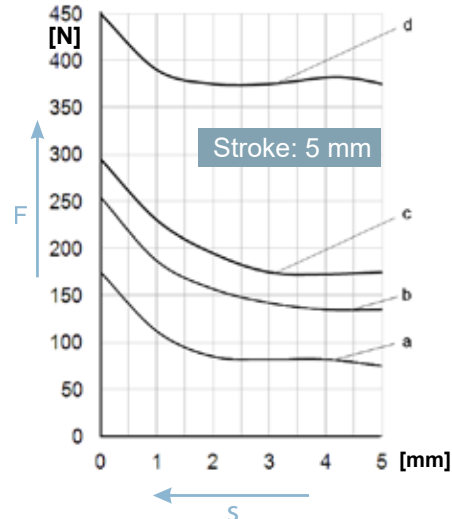

LCL060070 (43 11...06D00/D50)

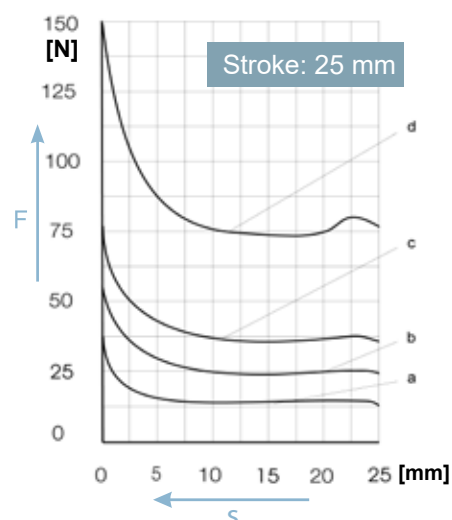
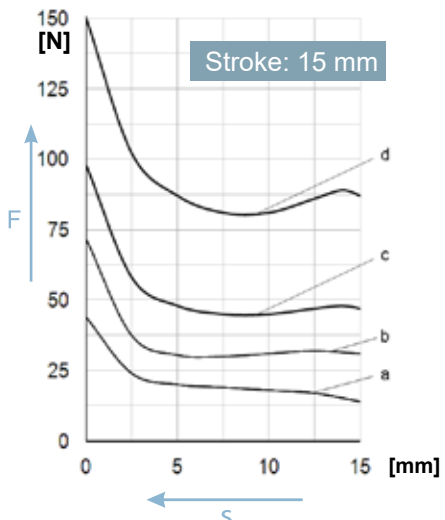

Duty cycle: a = 100% b = 40% c = 25% d = 5% Values in brackets = old designation

# Stroke Force Curves

LCL070080 (43 11...07D00/D50)

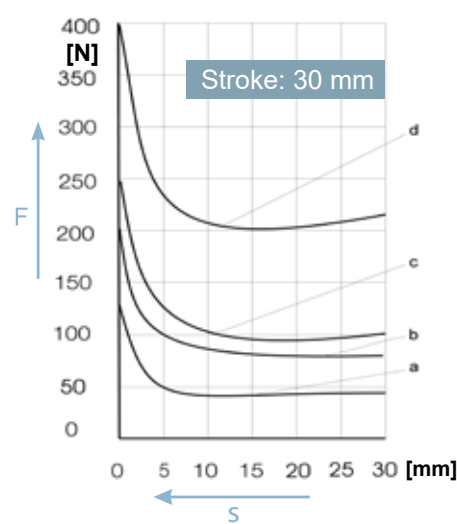
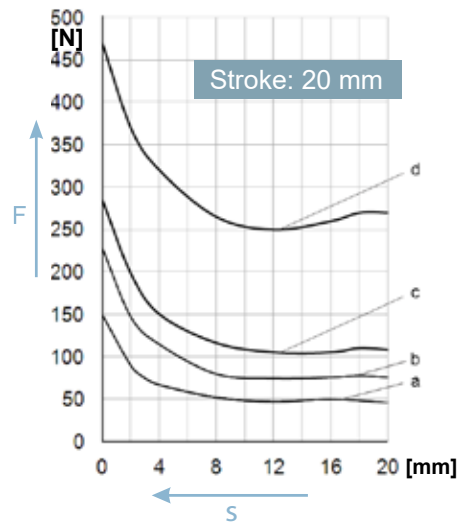
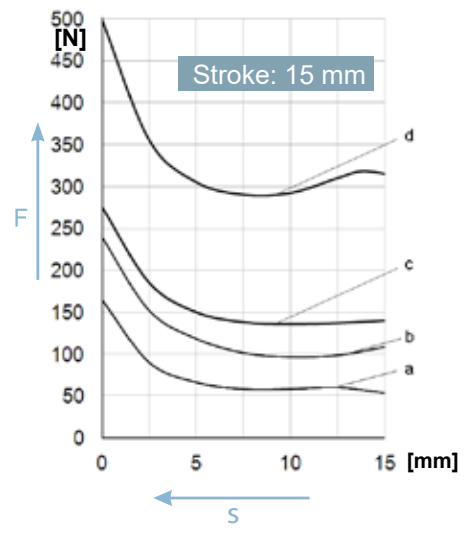
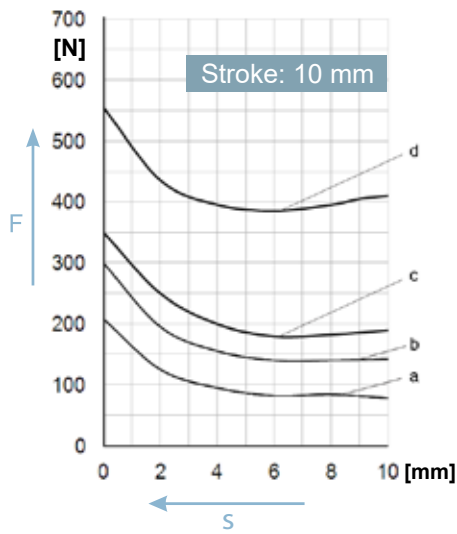
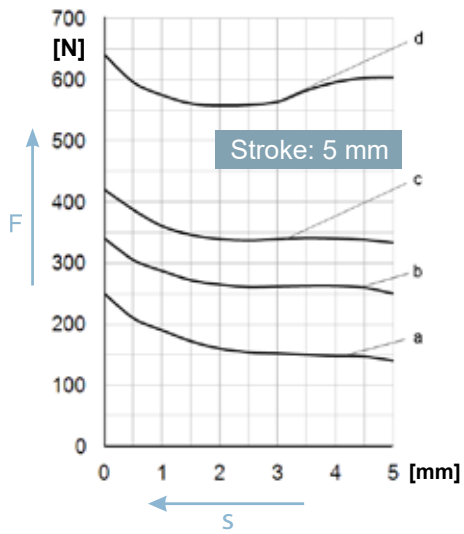

Duty cycle: a = 100% b = 40% c = 25% d = 5% Values in brackets = old designation

# Direct acting solenoid 4000628

The direct acting solenoid 4000628 is a closed frame solenoid with armature, punched bracket and two plates. The armature is guided in highly wear-resistant maintenance-free precision bearings on both sides.

Parts at risk of corrosion are galvanised and passivated. The armature is chemically nickel-plated. The stroke movement takes place from the stroke starting position to the stroke stop position by electro-magnetic forces, whereas the reset is accomplished by a pressure spring. The solenoids can be installed in any position. The force transfer should be in axial direction only.

Lateral load results in increased wear of bearing. If the solenoid is to be connected to an AC voltage of e.g. 230 V it can also be delivered with rectification. Either lateral or front mounting via threaded holes is possible.

## Excels by

**Cost-optimized design**

**Individual mounting options**

**Maintenance-free use**



### Accessories

- Fork head (Page 23)
- Return spring

### Model

- Protection class IP00
- Standard duty cycle = 100 % ED
- Standard rated voltage = 24 V DC
- Connection by flat plug

### Dimension Drawing

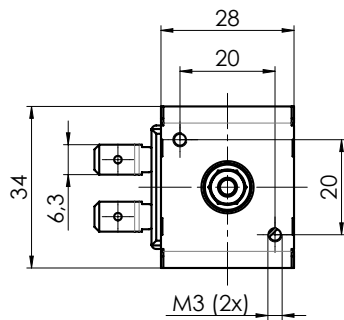

Armature position shown in de-energised condition

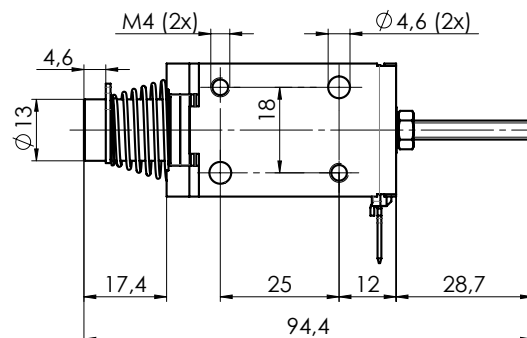
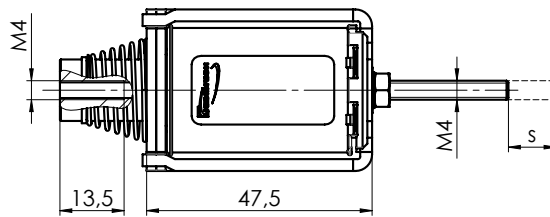

## Technical Data

Designation	4000628		
Duty cycle [%]	100	40	5
Stroke [mm]	10		
Rated power [W]	13.4	25.6	180
Armature weight [kg]	0.046		
Solenoid weight [kg]	0.225		
Insulation class	F		



Other voltages and duty cycles are available on request.  
+49 771 8009 3770 or [sales-ims@kendrion.com](mailto:sales-ims@kendrion.com)

## Stroke Force Curves

4000628

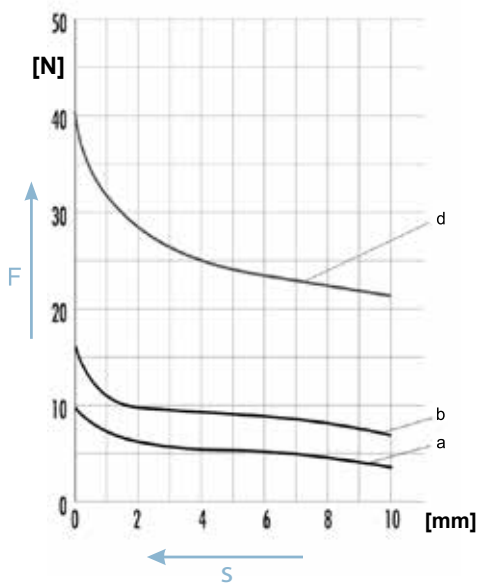

Duty cycle: a = 100% b = 40% d = 5%

# Direct acting solenoid 4000118

The direct acting solenoid 4000118 is a open frame solenoid with armature and punched bracket. The armature is guided in highly wear-resistant maintenance-free precision bearings on both sides.

Parts at risk of corrosion are galvanised and passivated. The armature is chemically nickel-plated.

The solenoids can be installed in any position. The force transfer should be in axial direction only. Lateral load results in increased wear of bearing

The mounting can be made by threaded holes at the frame base.

## Excels by

**Cost-optimized design**

**Return by return spring**

**Compact design**



### Accessories

- Fork head (Page 23)
- Optional without spring

### Model

- Lead wires - Protection class IP00
- Standard duty cycle = 100 % ED
- Standard related voltage = 24 V DC

### Dimension Drawing

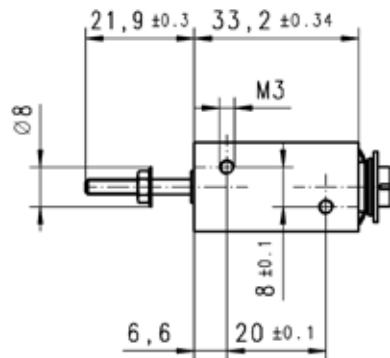

Armature position shown in energised condition

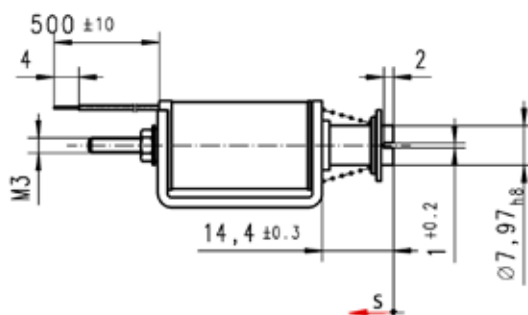

Armature position shown in currentless condition

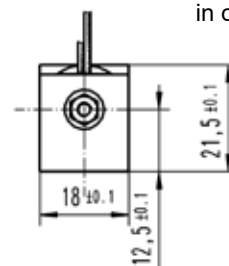

## Technical Data

Designation	4000118		
Duty cycle [%]	100	40	5
Stroke [mm]	8		
Rated power [W]	6	11.1	71.1
Armature weight [kg]	0.015		
Solenoid weight [kg]	0.060		
Insulation class	F		



Other voltages and duty cycles are available on request.  
+49 771 8009 3770 or [sales-ims@kendrion.com](mailto:sales-ims@kendrion.com)

## Stroke Force Curves

4000118

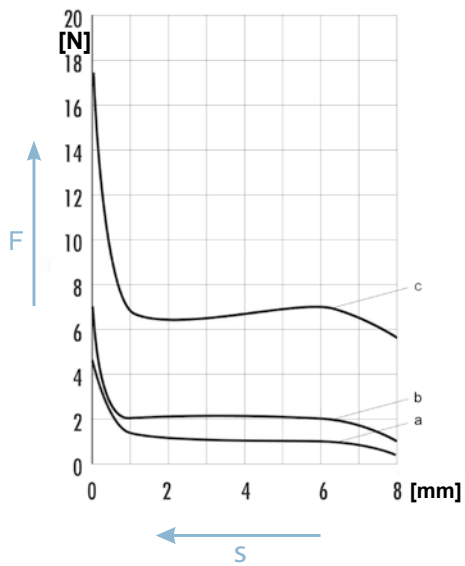

Duty cycle: a = 100% b = 40% c = 5%

# Direct acting solenoid LCL-C

The **C- Frame Solenoids** of the type series LCL are open frame solenoids with armature and punched bracket. For this armature guide a brass sleeve is used.

Parts at risk of corrosion are electro-galvanised.  
The armature is chemically nickel-plated.

Lateral mounting of the solenoid via thread.

## Excels by

**Optimized design**

**Pushing & pulling application**



### Accessories

- Fork head (Page 23)
- Optional available with return spring

### Model

- Lead wires - Protection class IP00
- Standard duty cycle = 100 % ED
- Standard related voltage = 24 V DC

### Dimension Drawing

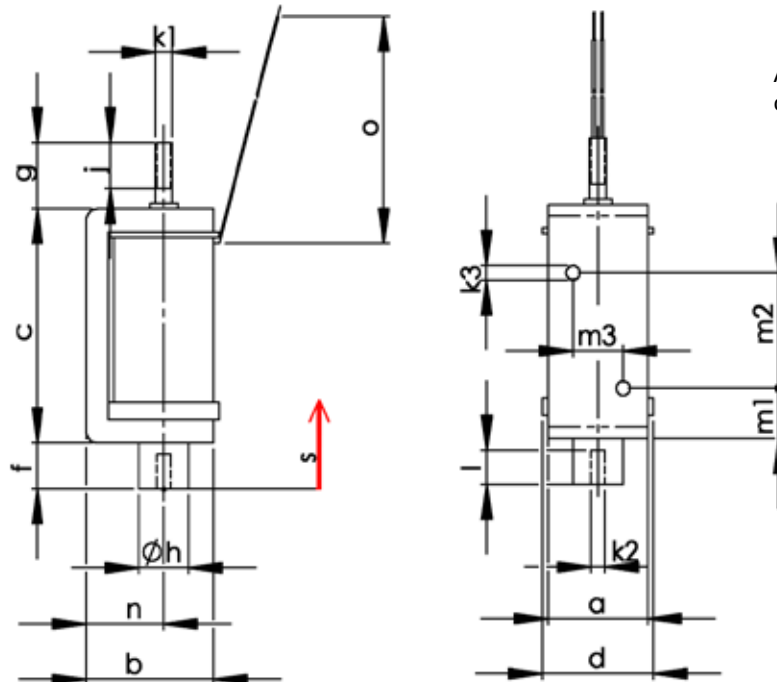

Armature position shown in currentless condition

### Dimensions in mm

Designation	a	b	c	d	s	f	g	h	i	k1	k2	k3	m1	m2	m3	l	n	o
LCL012015	12	14	30	13	3	5	12.5	6	8	M2	M3	M3	6	18	6	6	8	130
LCL015018	15	18	25	16	3	8	10	7	7	M2	M3	M3	8	10	9	6	10.2	130
LCL018022	18	22	31.5	20	4	6	10	8	8.5	M3	M3	M3	5.5	20	8	6	12	130
LCL018024	18	24	40.5	20	6	8	9.5	9	8.5	M3	M3	M3	8.7	20	9	6	13.5	130
LCL024031	24	31	40	26	6	8	10	12	10	M3	M3	M4	7.5	25	14	6	16.5	130



## Technical Data

Designation	LCL012015				LCL015018				LCL018022			
Duty cycle [%]	100	40	25	5	100	40	25	5	100	40	25	5
Stroke [mm]	3				3				4			
Rated power [W]	4	7.6	11	35	3.8	7.5	10.5	34.5	6.7	13.2	19	63
Response time [ms]	23	21	20	17	34	31	31	29	45	41	40	38
Release time [ms]	20	19	16	15	31	30	30	30	40	39	37	36
Armature weight [kg]	0.006				0.005				0.01			
Solenoid weight [kg]	0.02				0.04				0.06			
Insulation class	B				B				B			

Designation	LCL01824				LCL024031			
Duty cycle [%]	100	40	25	5	100	40	25	5
Stroke [mm]	6				6			
Rated power [W]	7.6	16	23.5	87	8.7	18	25.5	89
Response time [ms]	42	40	37	35	48	47	47	45
Release time [ms]	45	43	43	41	38	36	34	32
Armature weight [kg]	0.014				0.024			
Solenoid weight [kg]	0.08				0.15			
Insulation class	B				B			



Other voltages and duty cycles are available on request.  
 +49 771 8009 3770 or sales-ims@kendrion.com

## Stroke Force Curves

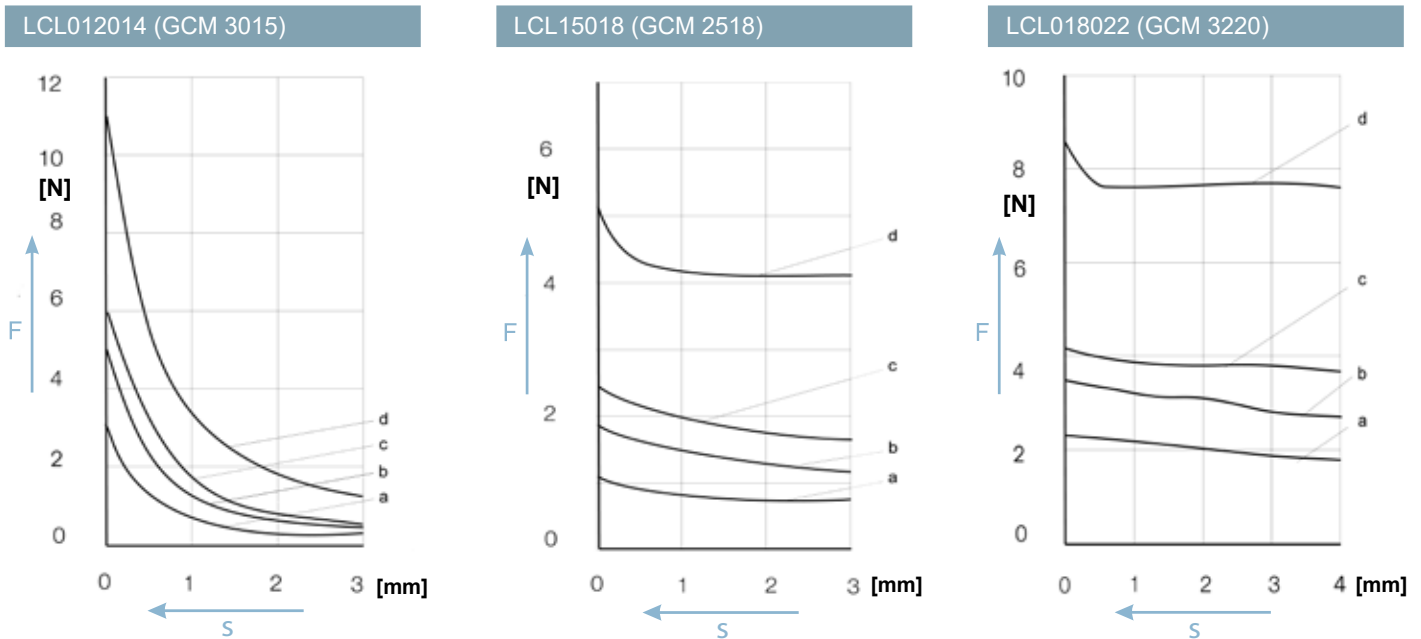

Duty cycle: a = 100% b = 40% c = 25% d = 5%      Klammerwerte = alte Bezeichnung

## Stroke Force Curves

LCL018024 (GCM 4025)

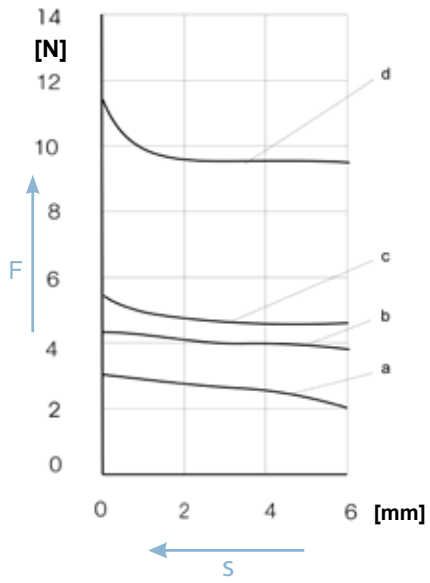

LCL024031 (GCM 4030)

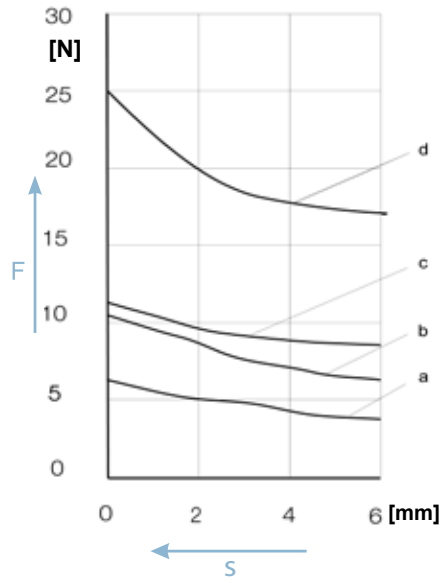

Duty cycle: a = 100% b = 40% c = 25% d = 5%      Klammerwerte = alte Bezeichnung

# Monostable direct acting solenoids LCM

Monostable direct acting solenoids of the LCM type series are single-action solenoids for short as well as intermittent duty with an ascending force-stroke characteristic. After the response phase integral permanent magnets hold the armature in the end position with a certain holding force in the de-energised state. Essentially, the electromagnetic force is used for the linear movement and the permanent magnetic force to hold the armature in the end position without the need for electrical power.

The release of the permanent magnetic force can be triggered by a voltage pulse. By using a compression spring this monostable version can be transformed into a bistable model. The armature is set back to the start position and held by a spring force.

The armature is guided in wear-resistant maintenance-free bearings on both sides.

Lateral mounting of the solenoid via thread.

## Excels by

**Currentless holding**

**Energy saving**

**High resistance to wear**



### Accessories

- Fork head (Page 23)
- Optional available with return spring

### Model

- Device - Protection class IP40
- Lead wires - Protection class IP00
- Standard rated voltage = 24 V DC

### Dimension Drawing

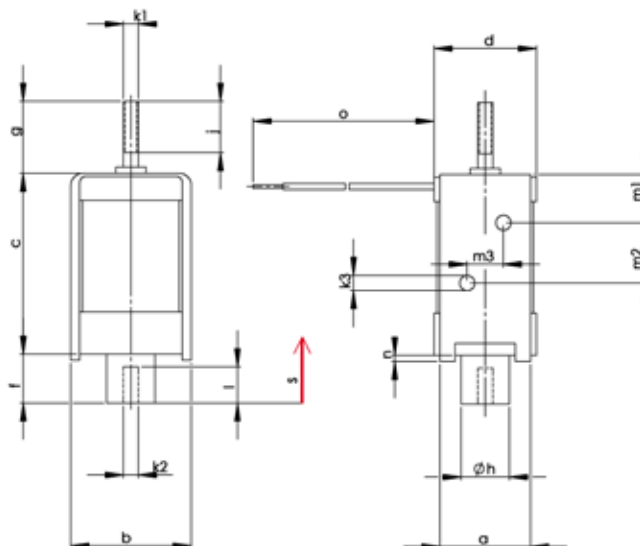

Armature position shown in currentless condition

### Dimensions in mm

Designation	a	b	c	d	e	f	g	h	j	k1	k2	k3	m1	m2	m3	l	n	o
LCM010015A00	10	15	25	12	2	4	10	6	7	M3	M3	M3	8	15	8	6	1	130
LCM015020A00	15	20	30	17	4	6	10	8	9	M3	M3	M3	8	10	6	6	1	130
LCM024030A00	24	30	40	25	8	10	10	12	9	M3	M3	M3	10	10	14	6	1	130
LCM025030A00	24	30	60	25	8	10	10	12	9	M3	M3	M3	10	20	14	6	1	130

## Technical Data

Designation	LCM010015A00				LCM015020A00				LCM024030A00				LCM025030A00			
Duty cycle [%]	100	40	25	5	100	40	25	5	100	40	25	5	100	40	25	5
Stroke [mm]	2				4				8				8			
Response time [ms]	45	37	34	30	60	56	54	50	80	75	70	60	83	75	75	70
Pull-in power consumption [W]	2.6	4.5	6	15.8	3.7	7.1	9.9	30.6	6.6	13.5	19.8	70.4	9.1	19	28	104
Armature weight [kg]	1.3				2.8				2.8				7.3			
Solenoid weight [kg]	0.005				0.011				0.032				0.045			
Insulation class	0.022				0.045				0.15				0.225			
Insulation class	E				E				E				E			



Other voltages and duty cycles are available on request.  
+49 771 8009 3770 or sales-ims@kendrion.com

## Stroke Force Curves

LCM010015A00 (SLP 2515)

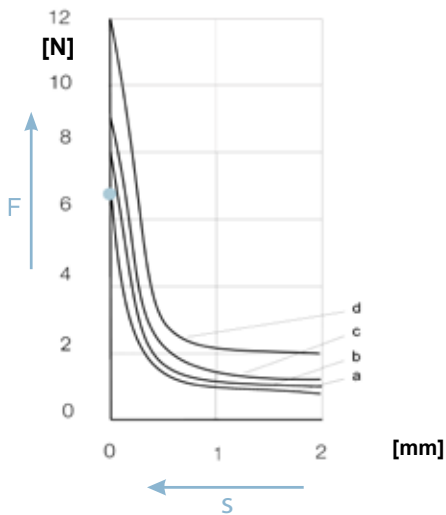

LCM015020A00 (SLP 3020)

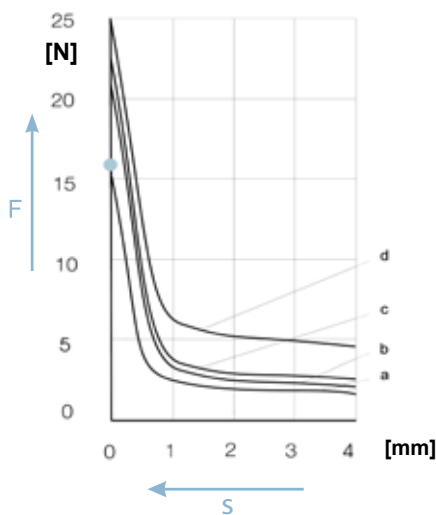

LCM024030A00 (SLP 4030)

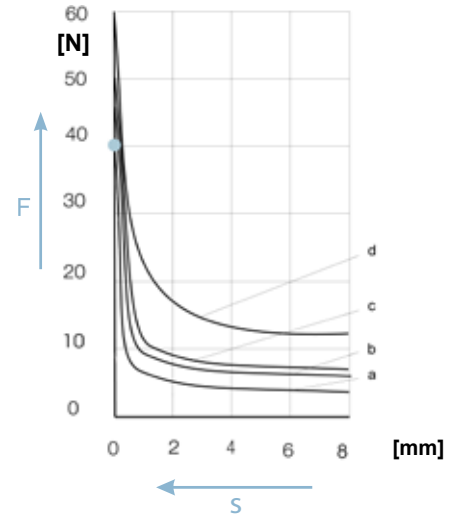

LCM025030A00 (SLP 6030)

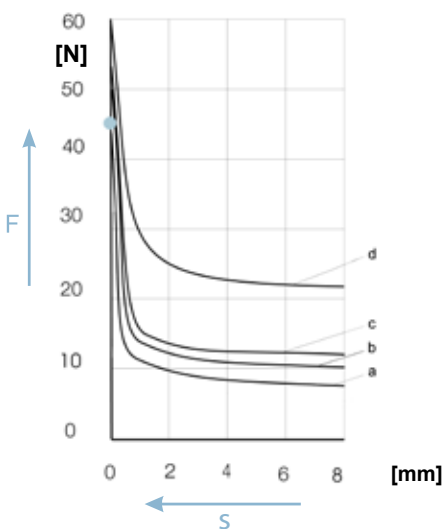

Duty cycle: a = 100% b = 40% c = 25% d = 5%

Values in brackets = old designation

● Permanent-magnetic holding force with air gap „0“

# Spring Set

A spring is clamped at the armature by means of a screw and a disc. As the spring is mounted to the outside of the solenoid this accessory cannot be mounted to the models IP54 with bellow.

The assembly is very easy, only an Allen key is required. The spring set can be used in combination with the LCL standard.

## Installation Note

Magnetic force is reduced by spring force.

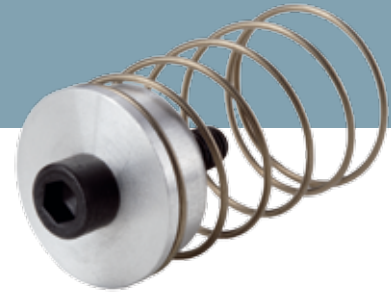

## Cross section

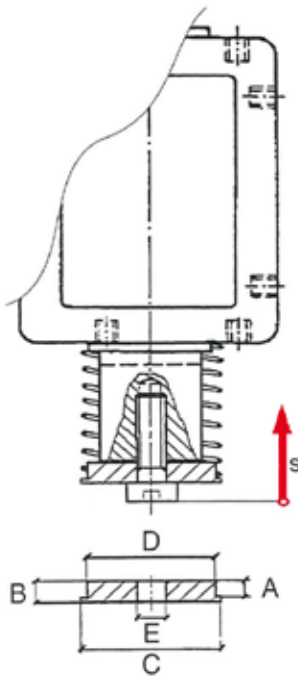

## Technical Data

Reset spring set for type	A [mm]	B [mm]	C [mm]	D [mm]	E [mm]
LCL030035	4	9	19	17	4.2
LCL040050	8.5	10.5	26	23	6.2
LCL048060	9	12	31	28	8.2
LCL060070	13	16	37.5	34	8.2
LCL070080	18	22	42.5	39	10.2

## Technical Data

	LCL030035			LCL040050				LCL048060			
Stroke [mm]	5	10	15	5	10	15	20	5	10	15	25
Spring force F [N] Initial force	2.3	1.7	1.1	5.5	4.5	3.5	2.5	9.046	7.88	6.82	4.7

	LCL060070				LCL070080				
Hub [mm]	5	10	15	25	5	10	15	20	30
Federkraft F [N] Initial force	63.16	41.5	30.1	7.3	19.125	15.5	14.25	13	10.5

# Plug-in connector acc. DIN EN 175301-803 with / without bridge rectifier depending on the voltage

The 2-pole plug-in connector with protective lead is a connection specially designed for electro-magnetic devices.

The cable outlet can be rotated 4 x 90° by inserting the contact carrier accordingly.

After attaching the plug-in connector to the pin plate of the device plus sealing it is secured with a machine screw supplied. This guarantees an exact seal of the combination and prevents the plug-in connector from being accidentally detached under vibration.

A cable gland Pg 11 (material no. 430006) serves to seal the cable. The contact elements are suitable for connecting-wire cross sections of up to 1.5 mm<sup>2</sup>. Air clearance and leakage paths acc. VDE 0110.

## Model

- Type 430006 without integrated bridge rectifier
- Type 430001 with integrated bridge rectifier



## Technical Data

Insulation class C  
Protection class IP 65 (in plugged in and secured condition)  
Plug load 2.5 A

## Dimension Drawing (Plug-in connector design A)

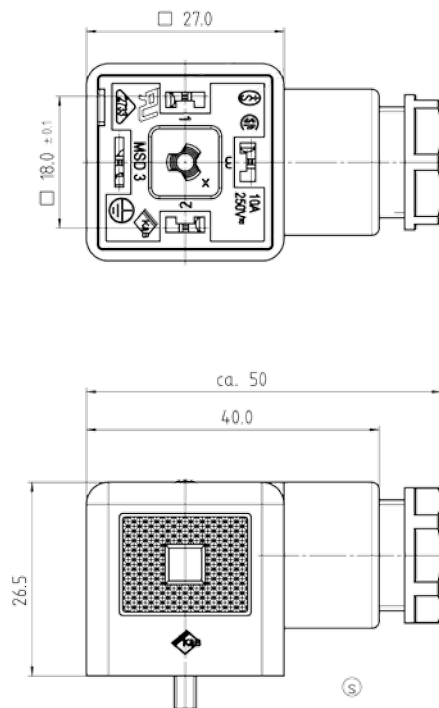

## Fork head acc. DIN 71752

Fork heads are used to connect all types of linear solenoids to force transfer elements such levers, push bars, valve flaps and sliding dampers. In many cases they enable rapid connection during assembly and also quick replacement of wear and spare parts.

The types without ES-bolt achieve the force transfer between fork head and customer application by a cylindrical pin with common safety elements.

The fork heads are electrogalvanised.

### Installation Notes

With its thread the fork head is screwed to the pull or push bar of the linear solenoid and secured with a locknut.



### Dimension Drawing

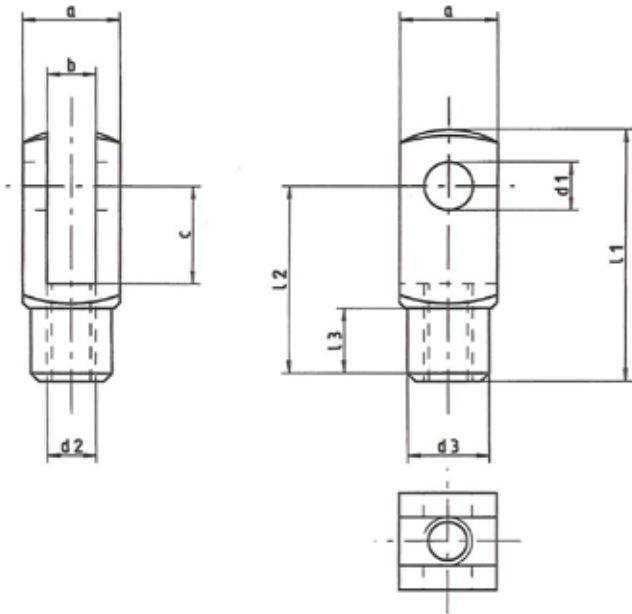

### Technical Data

Designation	a	b	c	d1	d2	d3	i1	i2	i3
GK 1	8	4	8	4	M4	8	21	16	6
GK 2	10	5	10	5	M5	9	26	20	8
GK 3	12	6	12	6	M6	10	31	24	9
GK 4	16	8	16	8	M8	14	42	32	12
GK 5	20	10	20	10	M10	18	52	40	15
GK 6	24	12	24	12	M12	20	62	48	18

## Snap-on fork pins acc. 71752

The use of a fork head with snap-on fork pin results in a quickly assembled and readily detachable connection (no tools required) between the linear solenoid and the component.

The spring clip ensures that the fork pin remains securely in position. The fork heads are electrogalvanised, the fork pins are electrogalvanised.



Technical Explanations

**Thermal Classes**

As shown in the table below thermal classes are classified according to DIN VDE 0580 / 07.2000 into insulation classes on the basis of their longterm thermal stability. Depending on the type our linear solenoids are manufactured in thermal classes E, B and F. If required by the application most devices can also be delivered in thermal class H.

Thermal class	Limit temperature °C	Limit overtemperature °C
Y	90	50
A	105	65
E	120	80
B	130	90
F	155	115
H	180	140

**Protection Classes [IP]**

Protection classes are indicated by a short symbol consisting of the two invariable code letters IP and two code letters for the degree of protection. The protection classes indicated are determined according to IEC 60529. They apply to protection against contact and against penetration of foreign substances. The second code letter applies to protection against penetration of water.

In case the protection class of e.g. the electrical connection deviates from that of the solenoid the protection class of the connection is indicated separately, e.g. housing IP 54, connection IP 00.

Code Letters Protection against contact and foreign substances	
0	no protection
1	protection against big foreign substances
2	protection against medium-sized foreign substances
3	protection against small foreign substances
4	protection against grain-shaped foreign substances
5	protection against dust deposit
6	protection against dust penetration

Code Letters Protection against water	
0	no protection
1	protection against vertical dripping water
2	protection against dripping water falling at an angle
3	protection against spray water
4	protection against splashing water
5	protection against flooding
6	protection against flooding
7	protection against immersion
8	protection against submersion

**Rated Modes of Operation**

**Continuous operation** is the operation during which the duty cycle is so long that the SteadyState temperature is reached.

**Intermittent operation** is the operation during which duty-cycle and currentless break alternate in regular and irregular intervals, the breaks being so short that the device cannot cool down to the reference temperature.

**Short time operation** is the operation during which the duty cycle is so short that the SteadyState time is not reached. The currentless break is so long that the solenoid cools down to the reference temperature.

**Technical Terms Related to Electricity**

**The rated voltage ( $U_N$ )** is the voltage with which the solenoid is operated in normal operation.

**The rated power ( $P_N$ )** is the power which results from the rated voltage and the rated current with DC solenoids of a coil temperature of 20°C.

**The rated current ( $I_N$ )** is the current which results from the rated voltage ( $U_N$ ) and the resistance (R20) with a coil temperature of 20°C.



**Technical Terms Related to Force**

**Magnetic force** is the exploitable mechanical force reduced by the friction which is generated in stroke direction. The magnetic force is safely reached with 90% rated voltage and maximum warming. With rated voltage the listed values rise by approx. 20%.

**Stroke force** is the magnetic force which acts outside taking the respective component of armature weight into consideration.

**Holding force** is the magnetic force in stroke end position with DC-solenoids; with AC-solenoids it is the average value of the magnetic force periodically fluctuating with the alternating current in stroke end position.

**Reset force** is the force required to reset the armature into stroke start position after switching off the excitation current.

**Relative duty cycle (% ED)** is the ratio between duty cycle and cycle time in per cent. It is calculate according to the following formula:

$$\% ED = (\text{duty cycle} / \text{cycle time}) * 100$$

In order to calculate the relative duty cycle the preferred value of the cycle time acc. DIN VDE 0580 item 3.2.2 of 5 minutes is usually taken as a basis.

If the cycle time is irregular the relative duty cycle is determined from the ratio between the sum of the duty cycles and the sum of the cycle times over a longer period of operation.

The maximum values of the duty cycle must not be exceeded. If the relative duty cycle was determined and its value exceeds the permitted maximum value acc. DIN VDE the higher %-ED has to be selected into the range of which the duty cycle fits in. (Tables 1 and 2)

**Cycle time** is the sum of the duty cycle and the currentless break. For DC-solenoids the cycle time is max. 5 minutes = 300s. This equals 12 switches per hour. The minimum cycle time is limited by the response and release times in connection with the relative duty cycle. For a cycle time of 300s there are maximum values for the duty cycle which must not be exceeded. In case the permitted duty cycle is exceeded a solenoid of the next higher relative duty cycle has to be selected.

If the duty cycle of 180s is exceeded the solenoid has to be selected for 100% ED (continuous energisation) or in special cases of the duty cycle calculated from the off/on ratio needs to be adapted by proper selection of the magnetic coil.

If the cycle time is irregular the relative duty cycle is determined from the ratio between the added duty cycles and the added cycle times over a longer period of operation.

Under playing sequence we understand a single or periodically returning sequence of values for cycle time.

Relative duty cycle (% ED)	5	15	25	40	60	100
Permitted maximum duty cycle (s)	15	45	75	120	180	random

Table 1

Switching number (S / h)	12		120		300		600		1200		3000	
	300		30		12		6		3		1.2	
Cycle time (s)	300		30		12		6		3		1.2	
% ED	t <sub>on</sub>	t <sub>off</sub>	t <sub>on</sub>	t <sub>off</sub>	t <sub>on</sub>	t <sub>off</sub>	t <sub>on</sub>	t <sub>off</sub>	t <sub>on</sub>	t <sub>off</sub>	t <sub>on</sub>	t <sub>off</sub>
5	15	285	1.5	28.5	0.6	11.4	0.3	5.7	0.15	2.85	0.06	1.14
15	45	255	4.5	25.5	1.8	10.2	0.9	5.1	0.45	2.55	0.18	1.02
40	120	180	12.0	18.0	4.8	7.2	2.4	3.6	1.20	1.80	0.48	0.72
60	180	120	18.0	12.0	7.2	4.8	3.6	2.4	1.80	1.20	0.72	0.48
100	random											

Table 2

# Overview of Catalogue



## Classic Line

- single-stroke solenoids
- compact design
- individual fixing
- mono- and bistable version



## High Performance Line

- square single-stroke solenoids
- high force with small installation space
- modular system
- short pull-in times



## High Power Line

- round single-stroke solenoids
- high forces and stroke travels
- short switching times
- also reversible solenoids

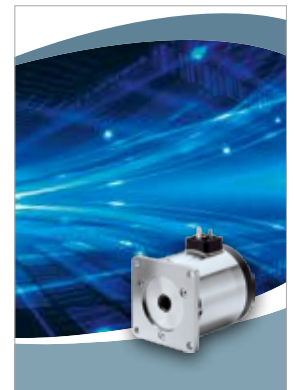

## Control Power Line

- control solenoids
- extremely fast
- switching
- short strokes
- precise switching



## Hahn CQ<sup>Line</sup>

- door holding magnet
- design and functionality
- VdS, CE, EN 1155,
- EN 14637 tested
- great variety



## Industrial Line

- industrial holding magnets
- high holding force with low power consumption
- compact design
- variable connections



## Oscillating Line

- vibratory solenoids
- wide product range for transportation of bulk material
- low wear
- compact design



### Elevator Line

- spreader solenoids
- especially designed for elevator brakes
- extremely high forces
- any mounting position



### ATEX Line

- explosion-proof solenoids
- prevent the occurrence of sparks and light arcs
- dynamic and reliable switching



### Locking Line

- locking solenoids
- high transverse forces
- integrated feedback of locking function
- compact design



### System Line

- operated by AC
- extremely short activation times
- very high pull-in forces

- **Rotary solenoids**
- **Assemblies**
- **Customer-specific solutions**

Please contact us for special or customer-specific solutions.

Kendrion Donaueschingen/Engelswies GmbH  
 Industrial Magnetic Systems  
 Sales Team Donaueschingen and Engelswies  
 Tel.: +49 771 8009 3770  
 Mail: [sales-ims@kendrion.com](mailto:sales-ims@kendrion.com)



WE MAGNETISE THE WORLD

If you do not find what you are looking for, please feel free to contact us!  
We will find the best solution for you.

**Germany : Headquarters**

Kendrion (Donaueschingen/Engelswies) GmbH  
August-Fischbach-Straße 1  
78166 Donaueschingen  
Telefon: +49 771 8009 0  
Telefax: +49 771 8009 3634  
sales-ims@kendrion.com

**Germany: Headquarters**

Kendrion (Donaueschingen/Engelswies) GmbH  
Hauptstraße 6  
72514 Inzigkofen-Engelswies  
Telefon: +49 7575 208 0  
Telefax: +49 7575 208 3190  
sales-ims@kendrion.com

For further contacts please refer to [www.kendrion.com](http://www.kendrion.com)

