

# POSIWIRE<sup>®</sup>

Cable Extension Position Sensors

**WS12**  
**Position Sensor**

Datasheet



### **Copyright**

© ASM GmbH  
Am Bleichbach 18-24  
85452 Moosinning  
Germany

The information presented in this data sheet does not form part of any quotation or contract, is believed to be accurate and reliable and may be changed without notice. No liability will be accepted by ASM for any consequence of its use. Publication thereof does not convey nor imply any license under patent or industrial or intellectual property rights. Applications that are described herein for any of these products are for illustrative purpose only.

ASM makes no representation or warranty that such applications will be suitable for the specified use without further testing or modification.

<b>Analog output, SSI output .....</b>	<b>5</b>
Specifications .....	5
Order code .....	7
<b>Dimensions .....</b>	<b>8</b>
Measurement range 100 ... 3000 mm, analog output, SSI output .....	8
<b>Magnetic encoder, analog output .....</b>	<b>9</b>
Specifications .....	9
Order code .....	10
<b>Magnetic encoder, analog output, programmable .....</b>	<b>11</b>
Specifications .....	11
Order code .....	12
<b>Magnetic encoder, analog output, redundant.....</b>	<b>13</b>
Specifications .....	13
Order code .....	14
<b>Magnetic encoder, digital output SSI .....</b>	<b>15</b>
Specifications .....	15
Order code .....	16
<b>Magnetic encoder, digital output CAN Bus.....</b>	<b>17</b>
Specifications .....	17
Order code .....	19
<b>Dimensions .....</b>	<b>20</b>
Measurement range 500 ... 3000 mm, magnetic encoder output .....	20
<b>Incremental encoder output .....</b>	<b>21</b>
Specifications .....	21
Order code .....	22
<b>Dimensions .....</b>	<b>23</b>
Measurement range 1250 ... 3000 mm, incremental encoder output .....	23
<b>Output specifications .....</b>	<b>24</b>
Analog outputs .....	24
Voltage divider R1K.....	24
Signal conditioner 10V and 10V5.....	25
Signal conditioner 420A .....	26
Signal conditioner 420T.....	27
Signal conditioner PMUI / PMUV .....	28
Signal conditioner ADSI .....	30
Magnetic encoder, analog output.....	32
Magnetic encoder, analog output, programmable .....	34
Magnetic encoder, analog output, redundant .....	36
Magnetic encoder, digital output SSI .....	38
Magnetic encoder, digital output CANopen .....	40
Magnetic encoder, digital output CAN SAE J1939 .....	41
Incremental outputs.....	42
Signal conditioner PP530 .....	42
Signal conditioner IE41LI and IE41HI .....	44

---

<b>Accessories.....</b>	<b>46</b>
Connector cable M12, 4 pin .....	46
Connector cable M12, 5 pin .....	47
Connector cable M12, 8 pin .....	48
Connector/bus cable M12, 5 pin CAN-Bus .....	49
T-connector for bus cable M12, 5 pin CAN-Bus .....	49
Terminating resistor M12, 5 pin CAN-Bus .....	49
Plug-in connector M12, 8 pin (straight coupling) .....	50

## Analog output, SSI output

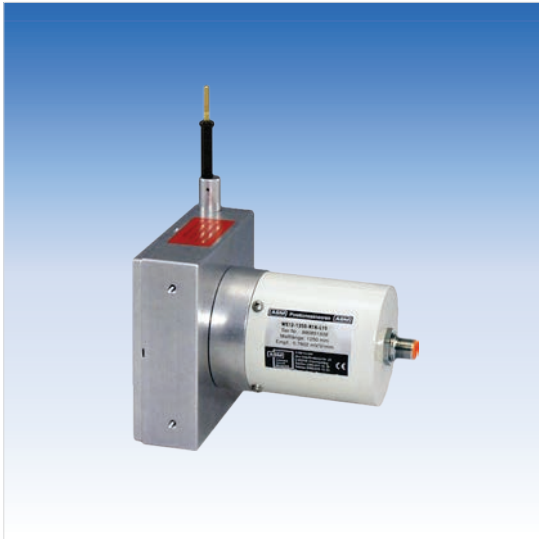

### Sensor features

- Measurement range up to 3000 mm
- Protection class IP67 (with mating connector only)
- Analog output, SSI output

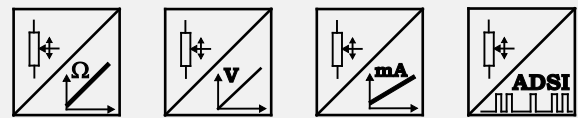

### Specifications

<b>Output</b>	<b>R1K</b> = Potentiometer 1 kΩ <b>10V</b> = Voltage 0 ... 10 V <b>420A</b> = Current 4 ... 20 mA, 2 wire <b>420T</b> = Current 4 ... 20 mA, 3 wire <b>PMUI</b> = Current output, programmable <b>PMUV</b> = Voltage output, programmable <b>ADSI</b> = Signal conditioner SSI 12 bit, replaced by MSS112 <b>ADSI14</b> = Signal conditioner SSI 14 bit, replaced by MSS114 <b>ADSI16</b> = Signal conditioner SSI 16 bit, replaced by MSS116
<b>Resolution</b>	Analog: quasi infinite
<b>Linearity</b>	±0.10% f.s. (standard) ±0.05% f.s. (optional)
<b>Sensing device</b>	Precision potentiometer
<b>Housing material</b>	Aluminium, stainless steel and plastic measuring cable: stainless steel
<b>Protection class</b>	IP67 (with mating connector only)
<b>Connection</b>	Connector M12, 8 pin
<b>Temperature range</b>	-20 ... +85 °C
<b>Weight</b>	Up to 1500 mm approx. 1 kg, from 2000 mm approx. 1,5 kg
<b>EMC</b>	DIN EN 61326-1:2013

<b>Cable forces</b> typical at = 20 °C	<b>Measurement range</b>	<b>Maximum pull-out force</b>	<b>Minimum pull-in force</b>
	[mm]	[N]	[N]
	100	5.2	2.8
	125	4.6	2.5
	500	5.9	2.6
	1000	5.5	2.4
	1250	4.8	2.1
	1500	10.4	6.4
	2000	8.1	5.0
	2500	6.7	4.0
	3000	6.2	3.0

**Order code**

**WS12** – 1 – 2 – 3 – 4 – 5

**1 Measurement range (in mm)**

100 / 125 / 500 / 1000 / 1250 / 1500 / 2000 / 2500 / 3000

**2 Output**

- R1K** = Potentiometer 1 kΩ
- 10V** = Voltage 0 ... 10 V
- 420A** = Current 4 ... 20 mA, 2 wire
- 420T** = Current 4 ... 20 mA, 3 wire
- PMUI** = Current output, programmable
- PMUV** = Voltage output, programmable
  
- ADSI** = Signal conditioner SSI 12 bit, replaced by MSS112
- ADSI14** = Signal conditioner SSI 14 bit, replaced by MSS114
- ADSI16** = Signal conditioner SSI 16 bit, replaced by MSS116

**3 Linearity**

- L10** = ±0.10% f.s. (standard)
- L05** = ±0.05% f.s. (optional)

**4 Cable fixing**

- M4** = M4 cable fixing
- SB0** = cable clip

**5 Connection**

- M12** = Connector M12, 8 pin

**Order example**

**WS12 – 3000 – 10V – L10 – M4 – M12**

**Accessories:**

**Connector cable (see page 48)**

## Dimensions

Measurement range 100 ... 3000 mm, analog output, SSI output

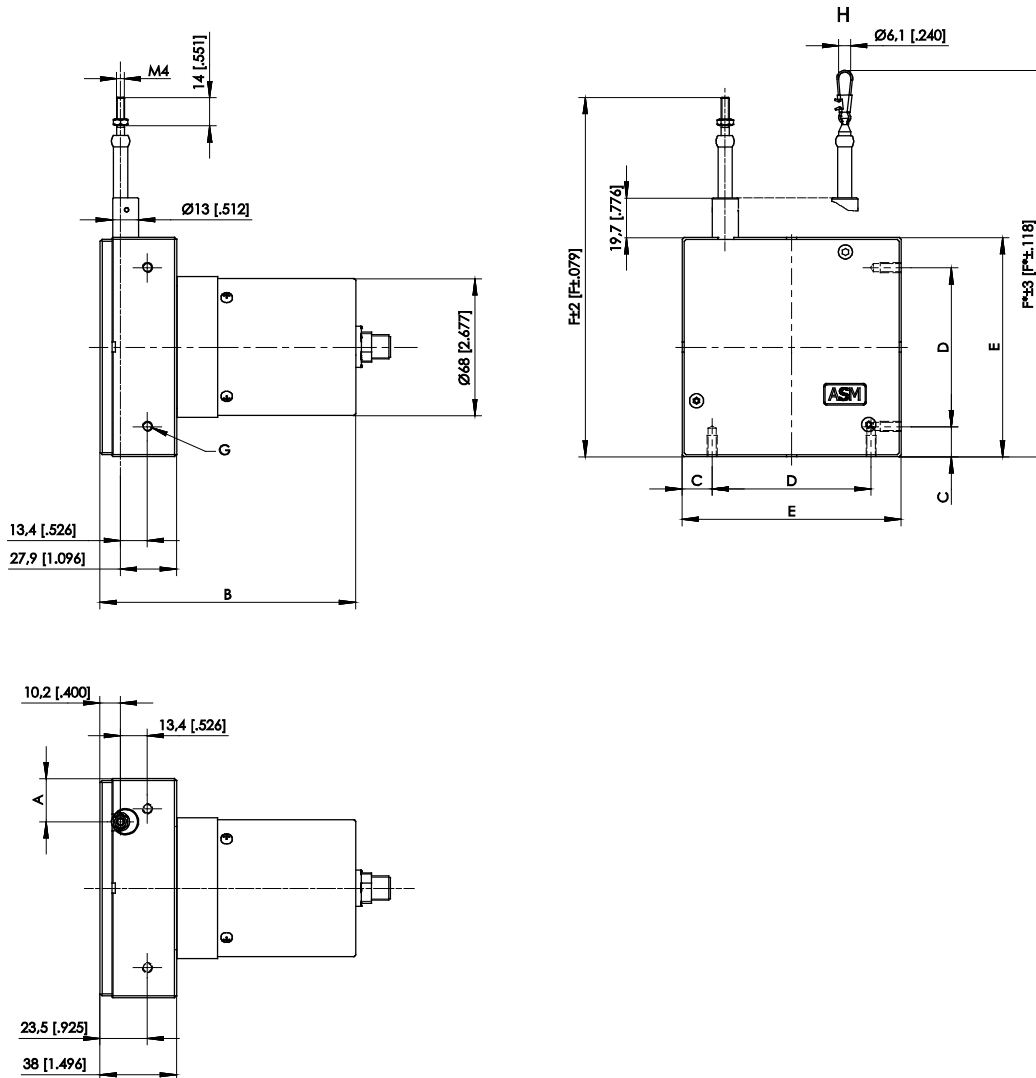

Dimensions in mm	Measurement range	A	B	C	D	E	F	F*
	100; 500; 1000	18.3	112	14	43	71	141	154
	125; 1250	14.5	112	14	43	71	141	154
	1500	10.7	127	14	43	71	141	154
	2000	21.5	127	15	79	109	179	192
	2500	13.3	127	15	79	109	179	192
	3000	9.2	127	15	79	109	179	192

G – 4 x M5 - 10 [0.394] deep  
 H – Option SB0

Dimensions in mm [inch]  
 Dimensions informative only.  
 For guaranteed dimensions consult factory.



## Magnetic encoder, analog output

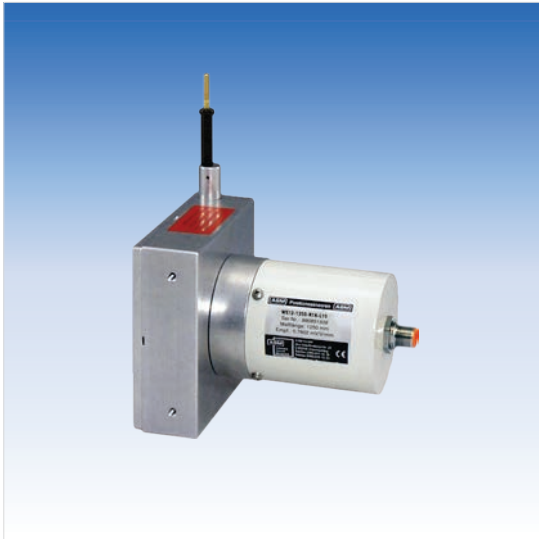

### Sensor features

- With magnetic absolute encoder
- Measurement range up to 3000 mm
- Protection class IP67 (with mating connector only)
- Analog output
- Absolute measurement

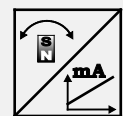
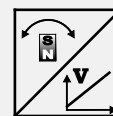

### Specifications

<b>Output</b>	<b>U2</b> = Voltage 0.5 ... 10 V <b>U8</b> = Voltage 0.5 ... 4.5 V <b>I1</b> = Current 4 ... 20 mA, 3 wire
<b>Resolution</b>	<0.002% f.s.
<b>Linearity</b>	±0.10% f.s. (standard) ±0.05% f.s. (optional)
<b>Sensing device</b>	Magnetic absolute encoder
<b>Housing material</b>	Aluminium, stainless steel and plastic measuring cable: stainless steel
<b>Protection class</b>	IP67 (with mating connector only)
<b>Connection</b>	Connector M12, 5 pin (standard) Connector M12, 8 pin ( optional)
<b>Shock</b>	DIN EN 60068-2-27:2010, 100 g/11 ms, 100 shocks
<b>Vibration</b>	DIN EN 60068-2-6:2008, 20 g 10 Hz-2 kHz, 10 cycles
<b>Temperature range</b>	-20 ... +85 °C
<b>Weight</b>	Up to 1500 mm approx. 1 kg, from 2000 mm approx. 1,5 kg
<b>EMC</b>	DIN EN 61326-1:2013

**Order code**

WS12 - 1 - 2 - 3 - 4 - 5 - 6

**1 Measurement range (in mm)**

500 / 1000 / 1250 / 1500 / 2000 / 2500 / 3000

**2 Output**

U2 = Voltage 0.5 ... 10 V  
 U8 = Voltage 0.5 ... 4.5 V  
 I1 = Current 4 ... 20 mA, 3 wire

**3 Signal characteristics**

A = increasing signal (e.g. 4 ... 20 mA)  
 D = decreasing signal (e.g. 20 ... 4 mA)

**4 Linearity**

L10 = ±0.10% f.s. (standard)  
 L05 = ±0.05% f.s. (optional)

**5 Cable fixing**

M4 = M4 cable fixing  
 SB0 = cable clip

**6 Connection**

M12A5 = Connector M12, 5 pin (standard)  
 M12A8 = Connector M12, 8 pin (optional)

**Order example**

WS12 - 3000 - U2 - A - L10 - M4 - M12A5

**Accessories:**

**Connector cable (see page 46)**

## Magnetic encoder, analog output, programmable

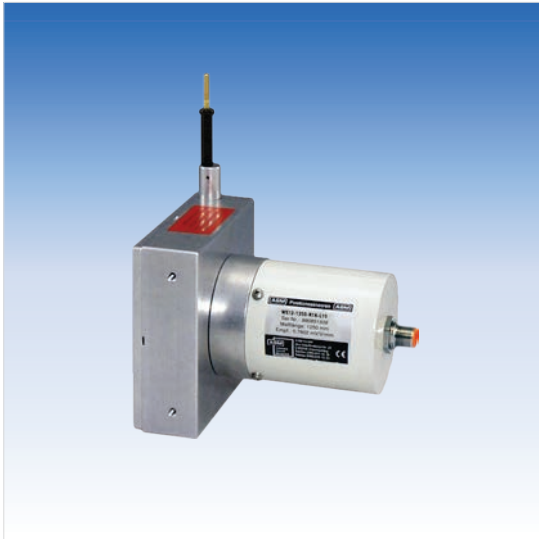

### Sensor features

- With magnetic absolute encoder
- Measurement range up to 3000 mm
- Protection class IP67 (with mating connector only)
- Analog output, programmable
- Absolute measurement

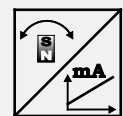
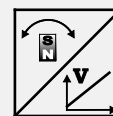

### Specifications

<b>Output</b>	<b>U2/PMU</b> = Voltage 0.5 ... 10 V, programmable <b>U8/PMU</b> = Voltage 0.5 ... 4.5 V, programmable <b>I1/PMU</b> = Current 4 ... 20 mA, 3 wire, programmable
<b>Resolution</b>	<0.002% f.s.
<b>Linearity</b>	±0.10% f.s. (standard) ±0.05% f.s. (optional)
<b>Sensing device</b>	Magnetic absolute encoder
<b>Housing material</b>	Aluminium, stainless steel and plastic measuring cable: stainless steel
<b>Protection class</b>	IP67 (with mating connector only)
<b>Connection</b>	Connector M12, 5 pin
<b>Shock</b>	DIN EN 60068-2-27:2010, 100 g/11 ms, 100 shocks
<b>Vibration</b>	DIN EN 60068-2-6:2008, 20 g 10 Hz-2 kHz, 10 cycles
<b>Temperature range</b>	-20 ... +85 °C
<b>Weight</b>	Up to 1500 mm approx. 1 kg, from 2000 mm approx. 1,5 kg
<b>EMC</b>	DIN EN 61326-1:2013

**Order code**

WS12 - 1 - 2 - 3 - 4 - 5 - 6

**1 Measurement range (in mm)**

500 / 1000 / 1250 / 1500 / 2000 / 2500 / 3000

**2 Output**

**U2/PMU** = Voltage 0.5 ... 10 V, programmable  
**U8/PMU** = Voltage 0.5 ... 4.5 V, programmable  
**I1/PMU** = Current 4 ... 20 mA, 3 wire, programmable

**3 Signal characteristics**

**A** = increasing signal (e.g. 4 ... 20 mA)  
**D** = decreasing signal (e.g. 20 ... 4 mA)

**4 Linearity**

**L10** = ±0.10% f.s. (standard)  
**L05** = ±0.05% f.s. (optional)

**5 Cable fixing**

**M4** = M4 cable fixing  
**SB0** = cable clip

**6 Connection**

**M12A5** = Connector M12, 5 pin

**Order example**

WS12 - 3000 - U2/PMU - A - L10 - M4 - M12A5

**Accessories:**

Connector cable (see page 47)

## Magnetic encoder, analog output, redundant

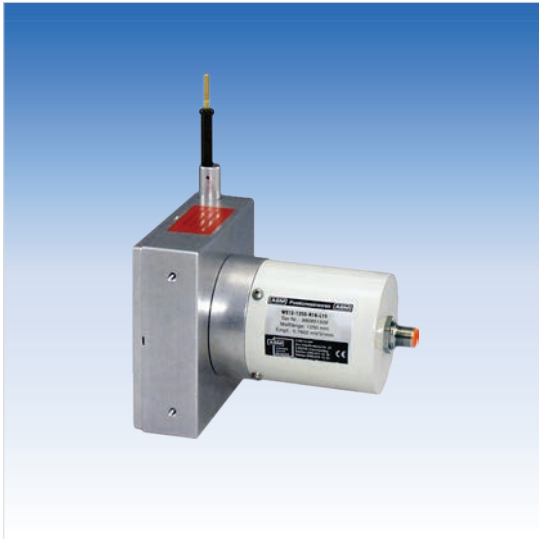

### Sensor features

- With magnetic absolute encoder
- Measurement range up to 3000 mm
- Protection class IP67 (with mating connector only)
- Analog output, redundant
- Absolute measurement

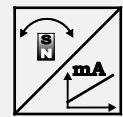
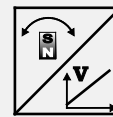

### Specifications

<b>Output</b>	<b>U2R</b> = Voltage 0.5 ... 10 V, redundant <b>U8R</b> = Voltage 0.5 ... 4.5 V, redundant <b>I1R</b> = Current 4 ... 20 mA, 3 wire, redundant
<b>Resolution</b>	<0.002% f.s.
<b>Linearity</b>	±0.10% f.s. (standard) ±0.05% f.s. (optional)
<b>Sensing device</b>	Magnetic absolute encoder
<b>Housing material</b>	Aluminium, stainless steel and plastic measuring cable: stainless steel
<b>Protection class</b>	IP67 (with mating connector only)
<b>Connection</b>	Connector M12, 8 pin
<b>Shock</b>	DIN EN 60068-2-27:2010, 100 g/11 ms, 100 shocks
<b>Vibration</b>	DIN EN 60068-2-6:2008, 20 g 10 Hz-2 kHz, 10 cycles
<b>Temperature range</b>	-20 ... +85 °C
<b>Weight</b>	Up to 1500 mm approx. 1 kg, from 2000 mm approx. 1,5 kg
<b>EMC</b>	DIN EN 61326-1:2013

**Order code**

WS12 - 1 - 2 - 3 - 4 - 5 - 6

**1 Measurement range (in mm)**

500 / 1000 / 1250 / 1500 / 2000 / 2500 / 3000

**2 Output**

U2R = Voltage 0.5 ... 10 V, redundant  
 U8R = Voltage 0.5 ... 4.5 V, redundant  
 I1R = Current 4 ... 20 mA, 3 wire, redundant

**3 Signal characteristics**

A/A = Output 1 increasing, output 2 increasing  
 A/D = Output 1 increasing, output 2 decreasing  
 D/D = Output 1 decreasing, output 2 decreasing

**4 Linearity**

L10 = ±0.10% f.s. (standard)  
 L05 = ±0.05% f.s. (optional)

**5 Cable fixing**

M4 = M4 cable fixing  
 SB0 = cable clip

**6 Connection**

M12A8 = Connector M12, 8 pin

**Order example**

WS12 - 3000 - I1R - A/D - L10 - M4 - M12A8

**Accessories:**

Connector cable (see page 48)

## Magnetic encoder, digital output SSI

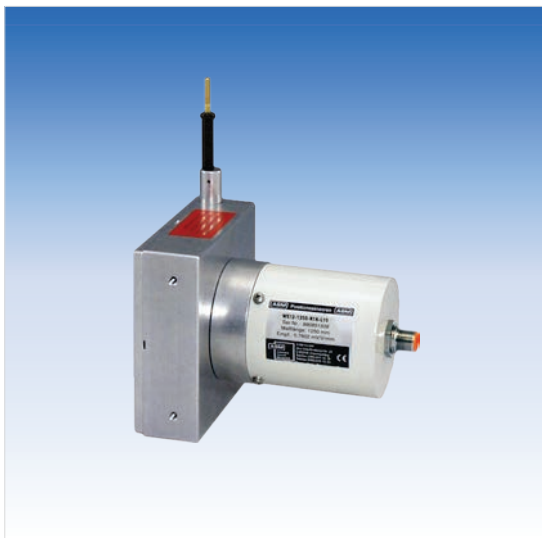

### Sensor features

- With magnetic absolute encoder
- Measurement range up to 3000 mm
- Protection class IP67 (with mating connector only)
- Digital output SSI
- Absolute measurement

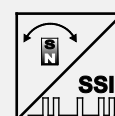

### Specifications

<b>Output</b>	<b>MSSI</b> = SSI synchronous serial interface
<b>Resolution</b>	10 / 50 / 100
<b>Linearity</b>	±0.10% f.s. (standard) ±0.05% f.s. (optional)
<b>Sensing device</b>	Magnetic absolute encoder
<b>Housing material</b>	Aluminium, stainless steel and plastic measuring cable: stainless steel
<b>Protection class</b>	IP67 (with mating connector only)
<b>Connection</b>	Connector M12, 8 pin
<b>Shock</b>	DIN EN 60068-2-27:2010, 100 g/11 ms, 100 shocks
<b>Vibration</b>	DIN EN 60068-2-6:2008, 20 g 10 Hz-2 kHz, 10 cycles
<b>Temperature range</b>	-20 ... +85 °C
<b>Weight</b>	Up to 1500 mm approx. 1 kg, from 2000 mm approx. 1,5 kg
<b>EMC</b>	DIN EN 61326-1:2013

**Order code**

**WS12** – 1 – 2 – 3 – 4 – 5 – 6

**1 Measurement range (in mm)**

500 / 1000 / 1250 / 1500 / 2000 / 2500 / 3000

**2 Resolution (in µm)**

10 / 50 / 100

**3 Output**

**MSSI** = SSI synchronous serial interface

**4 Linearity**

**L10** = ±0.10% f.s. (standard)

**L05** = ±0.05% f.s. (optional)

**5 Cable fixing**

**M4** = M4 cable fixing

**SB0** = cable clip

**6 Connection**

**M12A8** = Connector M12, 8 pin

**Order example**

**WS12 – 3000 – 50 – MSSI – L10 – M4 – M12A8**

**Accessories:**

**Connector cable (see page 48)**



## Magnetic encoder, digital output CAN Bus



### Sensor features

- With magnetic absolute encoder
- Measurement range up to 3000 mm
- Protection class IP67 (with mating connector only)
- Digital output CAN Bus
- Absolute measurement
- Optional redundant CAN Bus



### Specifications

<b>Output</b>	<b>MCANOP</b> = CANopen <b>MCANJ1939</b> = CAN SAE J1939 <b>MCANOPR</b> = CANopen redundant <b>MCANJ1939R</b> = CAN SAE J1939 redundant
<b>Resolution</b>	setting via CAN Bus
<b>Linearity</b>	±0.10% f.s. (standard) ±0.05% f.s. (optional)
<b>Sensing device</b>	Magnetic absolute encoder
<b>Housing material</b>	Aluminium, stainless steel and plastic measuring cable: stainless steel
<b>Protection class</b>	IP67 (with mating connector only)
<b>Connection</b>	Connector M12, 5 pin
<b>Temperature range</b>	-20 ... +85 °C
<b>Weight</b>	Up to 1500 mm approx. 1 kg, from 2000 mm approx. 1,5 kg
<b>EMC</b>	DIN EN 61326-1:2013

**Cable forces for sensors with magnetic encoder**

<b>Cable forces</b> typical at = 20 °C	<b>Measurement range</b>	<b>Maximum pull-out force</b>	<b>Minimum pull-in force</b>
	[mm]	[N]	[N]
	100	5.2	2.8
	125	4.6	2.5
	500	5.9	2.6
	1000	5.5	2.4
	1250	4.8	2.1
	1500	10.4	6.4
	2000	8.1	5.0
	2500	6.7	4.0
	3000	6.2	3.0

**Order code**

**WS12** – 1 – 2 – 3 – 4 – 5

**1 Measurement range (in mm)**

500 / 1000 / 1250 / 1500 / 2000 / 2500 / 3000

**2 Output**

**MCANOP** = CANopen  
**MCANJ1939** = CAN SAE J1939  
**MCANOPR** = CANopen redundant  
**MCANJ1939R** = CAN SAE J1939 redundant

**3 Linearity**

**L10** = ±0.10% f.s. (standard)  
**L05** = ±0.05% f.s. (optional)

**4 Cable fixing**

**M4** = M4 cable fixing  
**SB0** = cable clip

**5 Connection**

**M12/CAN** = Connector M12, 5 pin

**Order example**

**WS12 – 3000 – MCANOP – L10 – M4 – M12/CAN**

**Accessories:**

**Connector cable (see page 49)**

## Dimensions

Measurement range 500 ... 3000 mm, magnetic encoder output

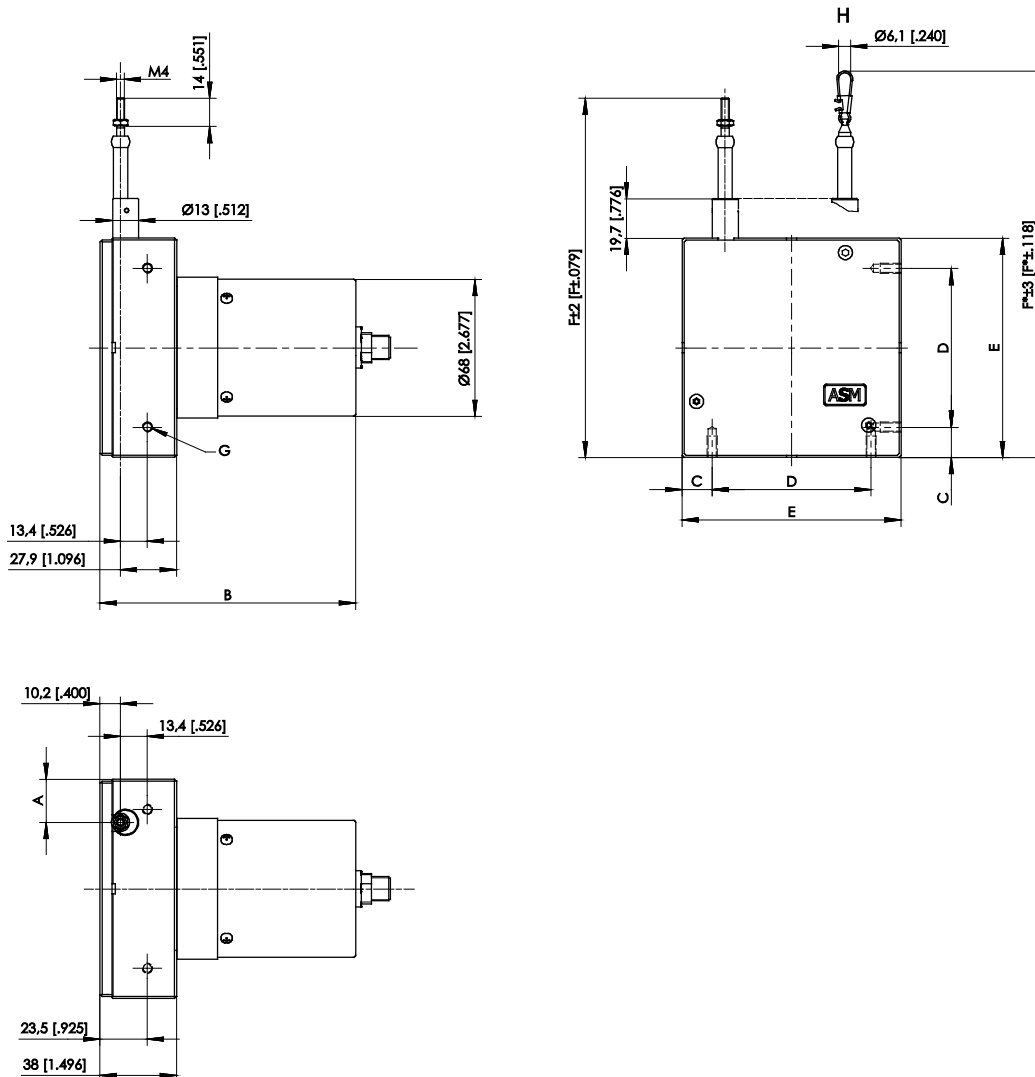

Dimensions in mm	Measurement range	A	B	C	D	E	F	F*
	500; 1000	18.3	112	14	43	71	141	154
	1250	14.5	112	14	43	71	141	154
	1500	10.7	127	14	43	71	141	154
	2000	21.5	127	15	79	109	179	192
	2500	13.3	127	15	79	109	179	192
	3000	9.2	127	15	79	109	179	192

G – 4 x M5 - 10 [0.394] deep  
 H – Option SB0

Dimensions in mm [inch]  
 Dimensions informative only.  
 For guaranteed dimensions consult factory.

## Incremental encoder output



### Sensor features

- Measurement range up to 3000 mm
- Protection class IP67 (with mating connector only)
- Incremental encoder output

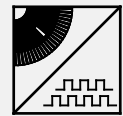

## Specifications

<b>Output</b>	<b>PP530</b> = Incremental output 5 ... 30 V <b>IE41LI</b> = Incremental encoder TTL compatible <b>IE41HI</b> = Incremental encoder HTL compatible
<b>Resolution</b>	10 or 5 pulses / mm (40 or 20 edges / mm)
<b>Linearity</b>	±0.05% f.s.
<b>Sensing device</b>	Incremental encoder
<b>Housing material</b>	Aluminium, stainless steel and plastic measuring cable: stainless steel
<b>Protection class</b>	IP67 (with mating connector only)
<b>Connection</b>	Connector M12, 8 pin
<b>Temperature range</b>	-20 ... +85 °C
<b>Weight</b>	Up to 1500 mm approx. 1 kg, from 2000 mm approx. 1,5 kg
<b>EMC</b>	DIN EN 61326-1:2013

Cable forces Typical at = 20 °C	Measurement range	Maximum pull-out force	Minimum pull-in force
	[mm]	[N]	[N]
	1250	6.6	2.7
	1500	10.6	6.5
	2000	5.7	4.1
	2500	5.7	4.1
	3000	5.8	4.0

**Order code**

**WS12** – 1 – 2 – 3 – 4 – 5

**1 Measurement range (in mm)**

1250 / 1500 / 2000 / 2500 / 3000

**2 Resolution**

**10** = 10 pulses / mm (1250, 1500 mm)  
**05** = 5 pulses / mm (2000, 2500, 3000 mm)  
 other numbers of pulses on request

**3 Output**

**PP530** = Incremental output 5 ... 30 V  
**IE41LI** = Incremental encoder TTL compatible  
**IE41HI** = Incremental encoder HTL compatible

**4 Cable fixing**

**M4** = M4 cable fixing  
**SB0** = cable clip

**5 Connection**

**M12** = Connector M12, 8 pin

**Order example**

**WS12 – 3000 – 5 – PP530 – M4 – M12**

**Accessories:**

**Connector cable (see page 48)**

## Dimensions

Measurement range 1250 ... 3000 mm, incremental encoder output

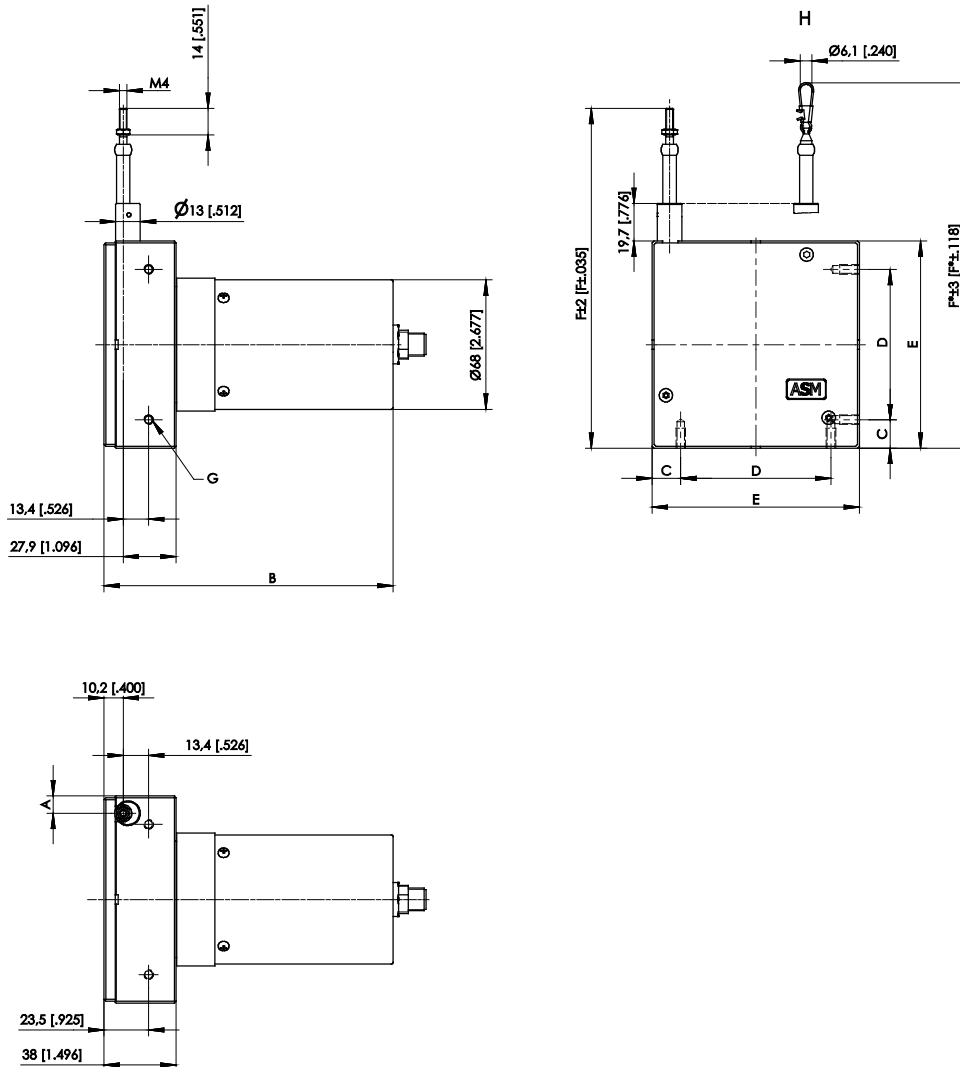

Dimensions in mm	Measurement range	A	B	C	D	E	F	F*
	1250	18.3	137	14	43	71	141	154
1500	10.7	152	14	43	71	141	154	
2000	9.2	152	15	79	109	179	192	
2500	9.2	152	15	79	109	179	192	
3000	9.2	152	15	79	109	179	192	

G – 4 x M5 - 10 [0.394] deep  
 H – Option SB0

Dimensions in mm [inch]  
 Dimensions informative only.  
 For guaranteed dimensions consult factory.

## Output specifications

### Analog outputs

#### Voltage divider R1K

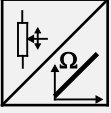
Potentiometer  	Excitation voltage	32 V DC max. at 1 kΩ (max. power 1 W)
	Potentiometer impedance	1 kΩ ±10 %
	Thermal coefficient	±25 x 10 <sup>-6</sup> / °C f.s.
	Sensitivity	Depends on the measuring range, individual sensitivity of the sensor is specified on the label
	Voltage divider utilization range	approx. 3 % ... 97 %
	Operating temperature	Refer to output specification
	EMC	DIN EN 61326-1:2013

### Output signals

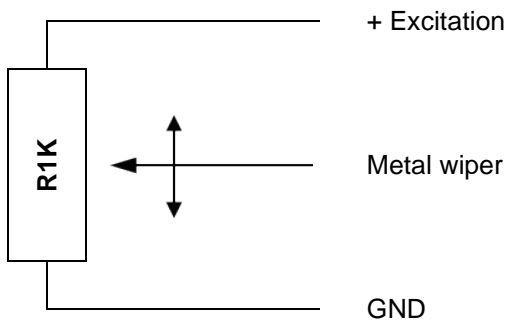

**Note:**

**The metal wiper of the potentiometer must be protected against current load!**

Electrical current flow impact on the wiper causes linearity errors and shortens the lifetime of the potentiometer.

Additional information:

[http://www.asm-sensor.com/asm/pdf/pro/ws\\_poti\\_technote\\_en.pdf](http://www.asm-sensor.com/asm/pdf/pro/ws_poti_technote_en.pdf)

### Signal wiring

Signal	Connector pin no.	Cable color	Cable color
Poti +	1	white	brown
Poti GND	2	brown	white
Poti slider	3	green	blue
-	4	yellow	black
-	5	grey	-
-	6	pink	-
-	7	blue	-
-	8	red	-

View to sensor connector



CONN-M12-8F

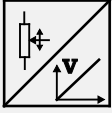

**Signal conditioner 10V and 10V5**

Voltage output 	Excitation voltage	18 ... 27 V DC non stabilized
	Excitation current	20 mA max.
	Output voltage	<b>10V:</b> 0 ... 10 V DC; <b>10V5:</b> 0.5 ... 10 V DC
	Output current	2 mA max.
	Output load	> 5 kΩ
	Stability (temperature)	$\pm 50 \times 10^{-6} / ^\circ\text{C}$ f.s.
	Protection	Reverse polarity, short circuit
	Output noise	0.5 mV <sub>RMS</sub>
	Operating temperature	Refer to output specification
	EMC	DIN EN 61326-1:2013

**Output signals**

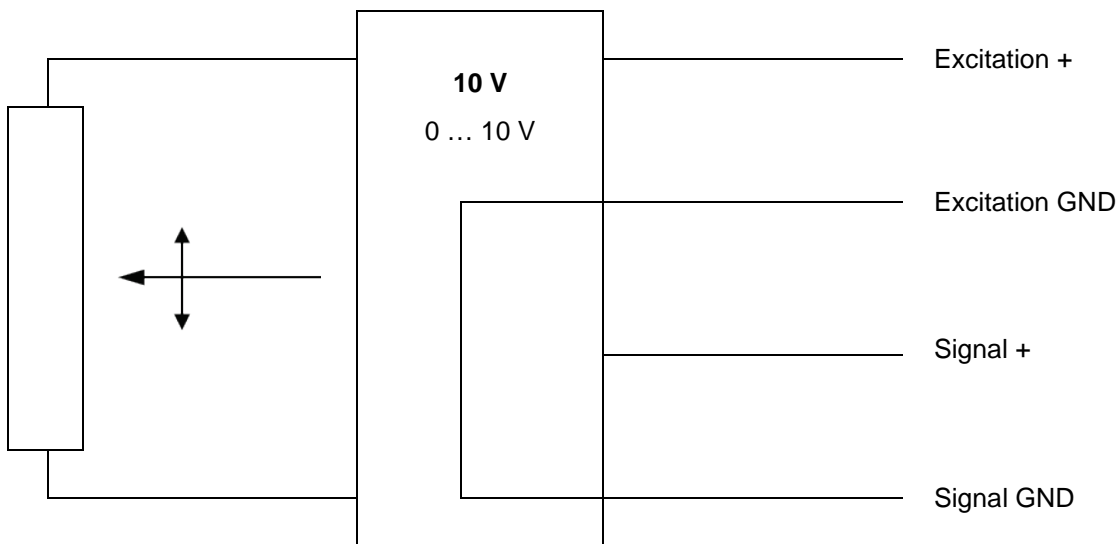

**Signal wiring**

Signal	Connector pin no.	Cable color	View to sensor connector
Excitation +	1	white	 CONN-M12-8F
Excitation GND	2	brown	
Signal +	3	green	
Signal GND	4	yellow	
Not connected	5	grey	
Not connected	6	pink	
Not connected	7	blue	
Not connected	8	red	

**Signal conditioner 420A**

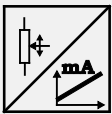
Current output (2 wire) 	Excitation voltage	12 ... 27 V DC non stabilized, measured at the sensor terminals
	Excitation current	35 mA max.
	Output current	4 ... 20 mA equivalent for 0 ... 100 % range
	Stability (temperature)	$\pm 100 \times 10^{-6} / ^\circ\text{C}$ f.s.
	Protection	Reversed polarity, short circuit
	Output noise	0.5 mV <sub>eff</sub>
	Operating temperature	Refer to output specification
	EMC	DIN EN 61326-1:2013

**Output signals**

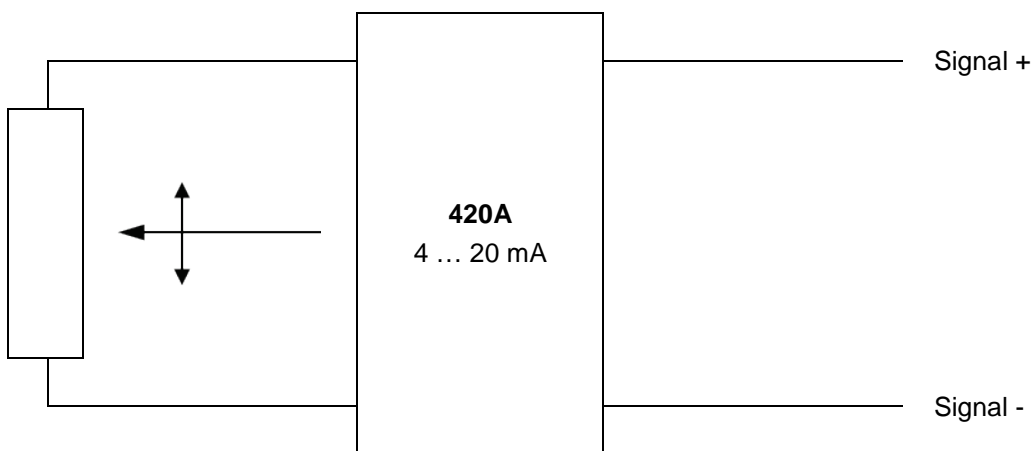

**Signal wiring**

Signal	Connector pin no.	Cable color	View to sensor connector
Signal +	1	white	 CONN-M12-8F
Signal -	2	brown	
Not connected	3	green	
Not connected	4	yellow	
Not connected	5	grey	
Not connected	6	pink	
Not connected	7	blue	
Not connected	8	red	

**Signal conditioner 420T**

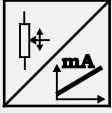
Current output (3 wire)  	Excitation voltage	18 ... 27 V DC non stabilized
	Excitation curren	40 mA max.
	Load resistor	350 Ω max.
	Output current	4 ... 20 mA equivalent for 0 ... 100 % range
	Stability (temperature)	$\pm 50 \times 10^{-6} / ^\circ\text{C}$ f.s.
	Protection	Reverse polarity, short circuit
	Output noise	0.5 mV <sub>RMS</sub>
	Operating temperature	Refer to output specification
	EMC	DIN EN 61326-1:2013

**Output signals**

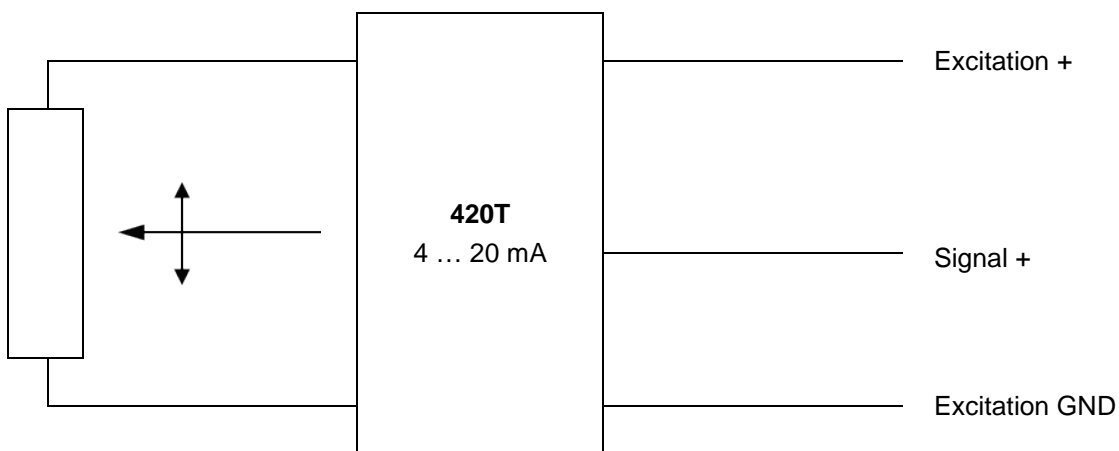

**Signal wiring**

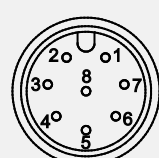
Signal	Connector pin no.	Cable color	View to sensor connector
Excitation +	1	white	
Excitation GND	2	brown	
Signal +	3	green	
Not connected	4	yellow	
Not connected	5	grey	
Not connected	6	pink	
Not connected	7	blue	
Not connected	8	red	

**Signal conditioner PMUI / PMUV**

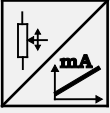
Voltage or current output (3 wire)  	Excitation voltage	18 ... 27 V DC
	Excitation current	50 mA max.
	Voltage output <b>PMUV</b>	0 ... 10 V
	Output current	10 mA max.
	Output load	1 kΩ min.
	Current output <b>PMUI</b>	4 ... 20 mA (3 wire)
	Working resistance	500 Ω max.
	Scaling	
	Activation of offset and gain adjust	Connect with excitation GND (0 V)
	Scalable range	90 % max. f.s.
	Stability (temperature)	±50 x 10 <sup>-6</sup> / °C f.s.
	Operating temperature	Refer to output specification
	Protection	Reversed polarity, short circuit
	EMC	DIN EN 61326-1:2013

**Output signals**

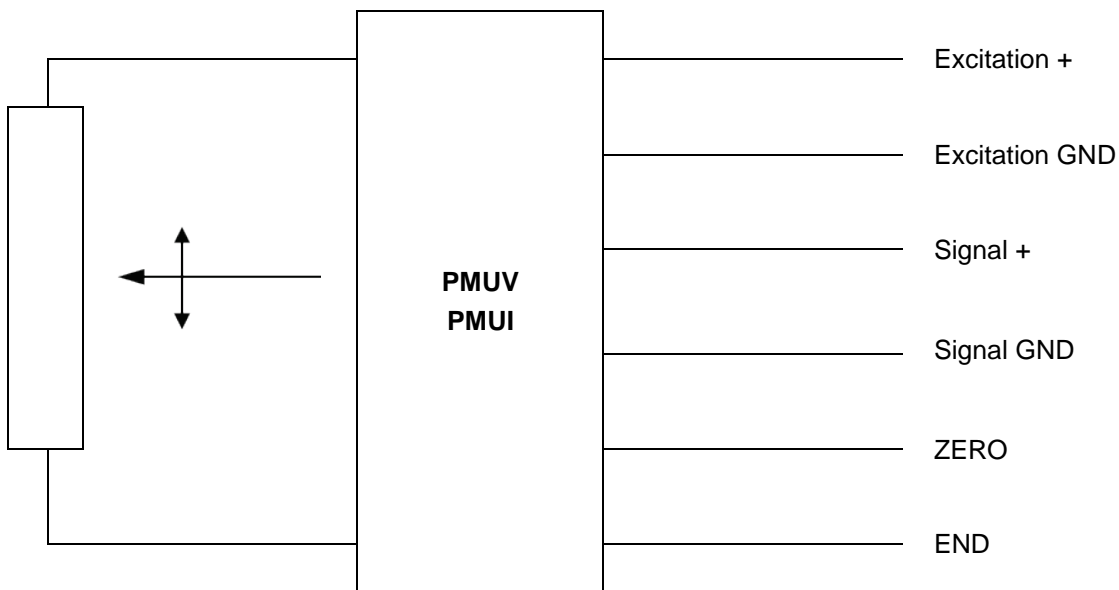

**Signal wiring PMUV / PMUI**

Signal	Connector pin no.	Cable color	View to sensor connector
Excitation +	1	white	 <p>CONN-M12-8F</p>
Excitation GND	2	brown	
Signal +	3	green	
Signal GND	4	yellow	
Not connected	5	grey	
Not connected	6	pink	
ZERO	7	blue	
END	8	red	

**Signal wiring PMUI2**

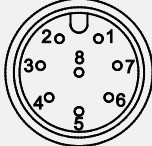
Signal	Connector pin no.	Cable color	View to sensor connector
Excitation +	1	white	 <p>CONN-M12-8F</p>
Excitation GND	2	brown	
Not connected	3	green	
Not connected	4	yellow	
Signal +	5	grey	
Signal GND	6	pink	
ZERO	7	blue	
END	8	red	

**Signal conditioner ADSI**

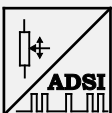
A/D converted synchronous serial 	Excitation volatge	11 ... 27 V DC
	Excitation current	200 mA max.
	Interface	EIA RS422, RS485, short-circuit proof
	Clock frequency	70 ... 500 kHz
	Code	Gray-Code, continuous progression
	Delay between pulse trains	30 µs min.
	Resolution	ADSI16: 16 bit (65536 counts) f.s. ADSI14: 14 bit (16384 counts) f.s. ADSI: 12 bit (4096 counts) f.s.
	Stability (temperature)	±50 x 10 <sup>-6</sup> / °C f.s.
	Operating temperature	-20 ... +85 °C
	EMC	DIN EN 61326-1:2013

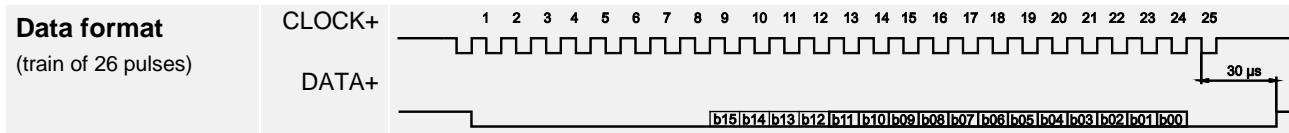

**Recommended processing circuit**

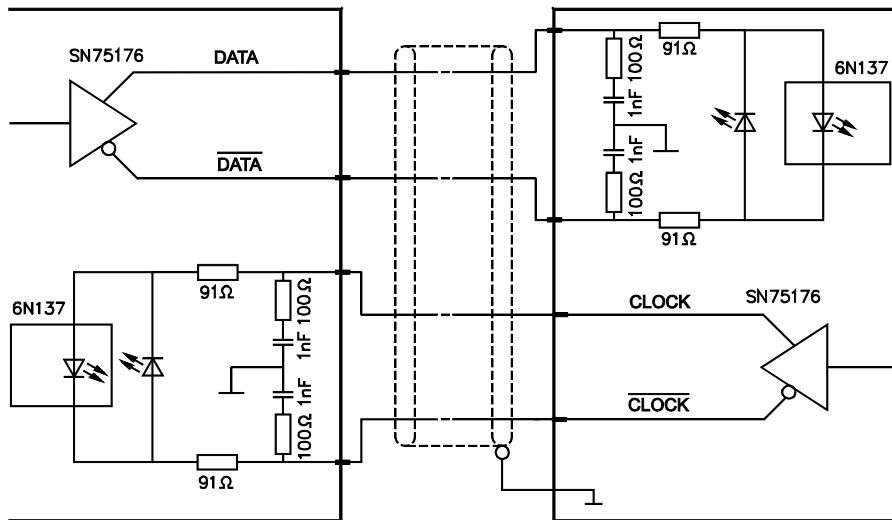

Transmission rate	Cable length	Baud rate
	< 50 m	< 300 kHz
	< 100 m	< 100 kHz

**Note:**

Extension of the cable length will reduce the maximum transmission rate.

**Signal wiring**

Signal	Connector pin no.	Cable color	View to sensor connector
Excitation +	1	white	
Excitation GND (0 V)	2	brown	
CLOCK	3	green	
$\overline{\text{CLOCK}}$	4	yellow	
DATA	5	grey	
$\overline{\text{DATA}}$	6	pink	
Shield, not connected	7	blue	
Not connected	8	red	

CONN-M12-8F

## Magnetic encoder, analog output

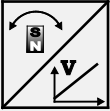
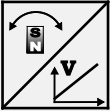
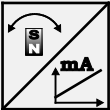
<b>U2</b> Voltage output 0.5 ... 10 V 	Excitation voltage	8 ... 36 V DC
	Excitation current	20 mA typical at 24 V DC 38 mA typical at 12 V DC max. 50 mA
	Output voltage	0.5 ... 10 V DC
	Output current	2 mA max.
	Measuring rate	1 kHz standard
	Stability (temperature)	$\pm 50 \times 10^{-6} / ^\circ\text{C}$ f.s. (typical)
	Protection	Reverse polarity, short circuit
	Operating temperature	See specification of the respective sensor
	EMC	DIN EN 61326-1:2013
<b>U8</b> Voltage output 0.5 ... 4.5 V 	Excitation voltage	8 ... 36 V DC
	Excitation current	17 mA typical at 24 V DC 32 mA typical at 12 V DC 50 mA max.
	Output voltage	0.5 ... 4.5 V DC
	Output current	2 mA max.
	Measuring rate	1 kHz standard
	Stability (temperature)	$\pm 50 \times 10^{-6} / ^\circ\text{C}$ f.s. (typical)
	Protection	Reverse polarity, short circuit
	Operating temperature	See specification of the respective sensor
	EMC	DIN EN 61326-1:2013
<b>I1</b> Current output 4 ... 20 mA, 3 wires 	Excitation voltage	8 ... 36 V DC
	Excitation current	typical 36 mA at 24 V DC typical 70 mA at 12 V DC 120 mA max.
	Load $R_L$	500 $\Omega$ max.
	Output current	4 ... 20 mA
	Measuring rate	1 kHz standard
	Stability (temperature)	$\pm 50 \times 10^{-6} / ^\circ\text{C}$ f.s. (typical)
	Protection	Reverse polarity, short circuit
	Operating temperature	See specification of the respective sensor
	EMC	DIN EN 61326-1:2013

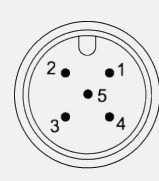

**Signal wiring**

Signal	Connector pin no.	Cable connection	View to the sensor connector
Excitation +	1	brown	
Signal	2	white	
GND	3	blue	
Do not connect!	4	black	
Do not connect!	5	(grey)	

**Signal diagram**

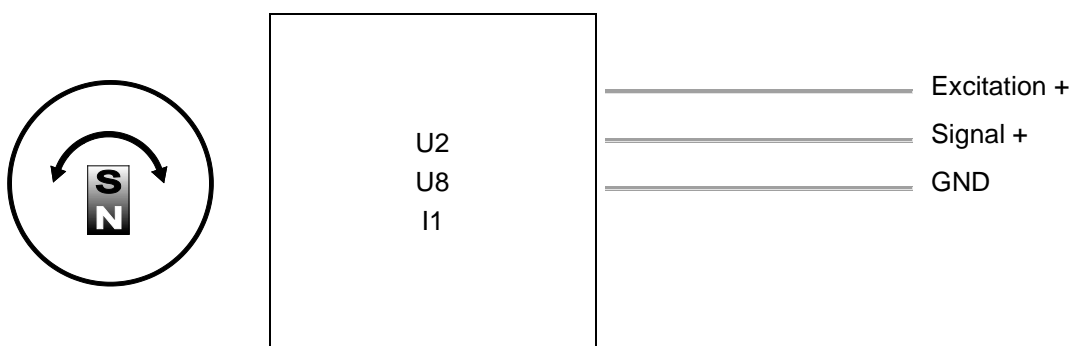

**Magnetic encoder, analog output, programmable**

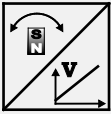
<p><b>U2/PMU</b></p> <p>Voltage output 0.5 ... 10 V</p> 	Excitation voltage	8 ... 36 V DC
	Excitation current	20 mA typical at 24 V DC 38 mA typical at 12 V DC max. 50 mA
	Output voltage	0,5 ... 10 V DC
	Output current	2 mA max.
	Measuring rate	1 kHz standard
	Stability (temperature)	$\pm 50 \times 10^{-6} / ^\circ\text{C}$ f.s. (typical)
	Protection	Reverse polarity, short circuit
	Operating temperature	See specification of the respective sensor
	EMC	EN 61326-1:2013

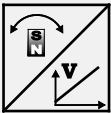
<p><b>U8/PMU</b></p> <p>Voltage output 0.5 ... 4.5 V</p> 	Excitation voltage	8 ... 36 V DC
	Excitation current	17 mA typical at 24 V DC 32 mA typical at 12 V DC max. 50 mA
	Output voltage	0.5 ... 4.5 V DC
	Output current	2 mA max.
	Measuring rate	1 kHz standard
	Stabilität (Temperatur)	$\pm 50 \times 10^{-6} / ^\circ\text{C}$ f.s. (typical)
	Protection	Reverse polarity, short circuit
	Operating temperature	See specification of the respective sensor
	EMC	DIN EN 61326-1:2013

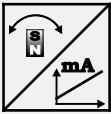
<p><b>I1/PMU</b></p> <p>Current output 4 ... 20 mA, 3 wires</p> 	Excitation voltage	8 ... 36 V DC
	Excitation current	typical 36 mA at 24 V DC typical 70 mA at 12 V DC max. 120 mA
	Load $R_L$	500 $\Omega$ max.
	Output current	4 ... 20 mA
	Measuring rate	1 kHz standard
	Stability (temperature)	$\pm 50 \times 10^{-6} / ^\circ\text{C}$ f.s. (typical)
	Protection	Reverse polarity, short circuit
	Operating temperature	See specification of the respective sensor
	EMC	DIN EN 61326-1:2013

**Signal wiring**

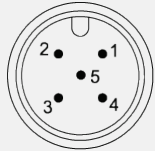
Signal	Connector pin no.	Cable color	View to sensor connector
Excitation +	1	brown	
Signal	2	white	
GND	3	blue	
Do not connect!	4	black	
SPAN/ZERO	5	grey	

**Signal diagram**

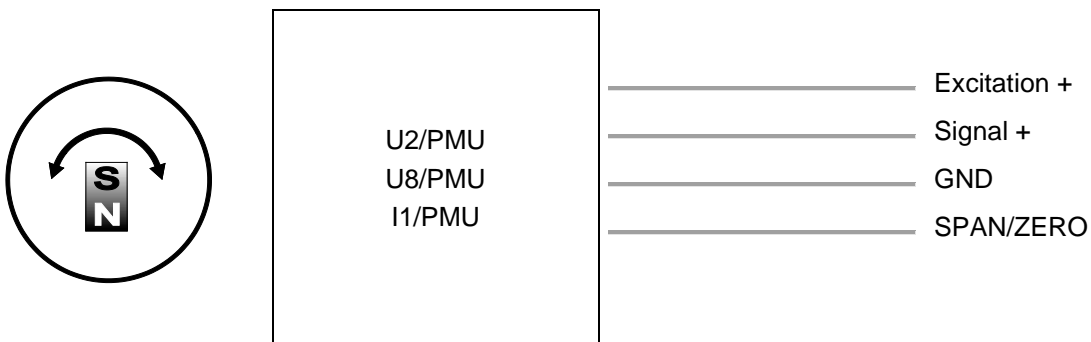

**Option -PMU**

**Programming of the start and end value by the customer**

Teach-In of start and end value for the options U2/PMU, I1/PMU, U8/PMU is provided by a binary signal SPAN/ZERO. At the start position connect signal SPAN/ZERO for a period of 2 ... 3 seconds to GND via push button. At the end position connect signal SPAN/ZERO for a period of 5 ... 6 seconds to GND via a push button. The scaling taught in that way will be stored non-volatile.

To reset the sensor to factory default signal ZERO/END must be connected to ground while powering up the sensor for 2 ... 3 seconds. For the option PMZ only teach-in of ZERO position is possible.

**Magnetic encoder, analog output, redundant**

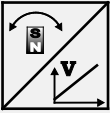
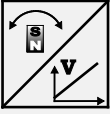
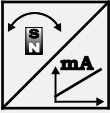
<p><b>U2R</b></p> <p>Voltage output 0.5 ... 10 V</p> 	Excitation voltage	8 ... 36 V DC
	Excitation current	20 mA typical at 24 V DC 38 mA typical at 12 V DC max. 50 mA per channel
	Output voltage	0.5 ... 10 V DC
	Output current	2 mA max.
	Measuring rate	1 kHz standard
	Stability (temperature)	$\pm 50 \times 10^{-6} / ^\circ\text{C}$ f.s. (typical)
	Protection	Reverse polarity, short circuit
	Operating temperature	See specification of the respective sensor
	EMC	DIN EN 61326-1:2013
<p><b>U8R</b></p> <p>Voltage output 0.5 ... 4.5 V</p> 	Excitation voltage	8 ... 36 V DC
	Excitation current	17 mA typical at 24 V DC 32 mA typical at 12 V DC max. 50 mA per channel
	Output voltage	0.5 ... 4.5 V DC
	Output current	2 mA max.
	Measuring rate	1 kHz standard
	Stability (temperature)	$\pm 50 \times 10^{-6} / ^\circ\text{C}$ f.s. (typical)
	Protection	Reverse polarity, short circuit
	Operating temperature	See specification of the respective sensor
	EMC	DIN EN 61326-1:2013
<p><b>I1R</b></p> <p>Current output 4 ... 20 mA, 3 wires</p> 	Excitation voltage	8 ... 36 V DC
	Excitation current	36 mA typical at 24 V DC 76 mA typical at 12 V DC max. 120 mA per channel
	Load $R_L$	500 $\Omega$ max.
	Output current	4 ... 20 mA
	Measuring rate	1 kHz standard
	Stability (temperature)	$\pm 50 \times 10^{-6} / ^\circ\text{C}$ f.s. (typical)
	Protection	Reverse polarity, short circuit
	Operating temperature	See specification of the respective sensor
	EMC	DIN EN 61326-1:2013

**Signal wiring**

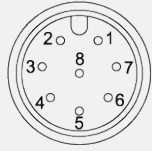
Channel	Signal	Connector pin no.	Cable color	View to the sensor connector
1	Excitation +	1	white	
1	Signal	2	brown	
1	GND	3	green	
1	Do not connect!	4	yellow	
2	Excitation +	5	grey	
2	Signal	6	pink	
2	GND	7	blue	
2	Do not connect!	8	red	

**Signal diagram**

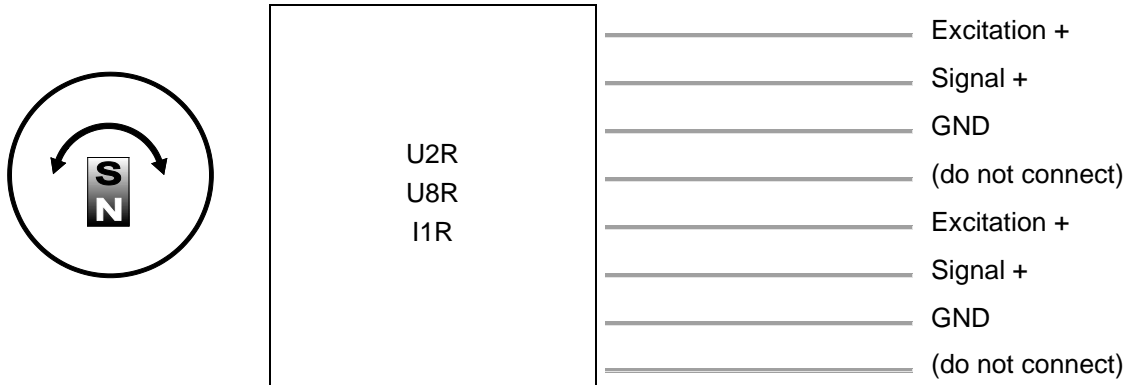

### Magnetic encoder, digital output SSI

<b>MSSI</b> Synchronous serial SSI 	Interface	EIA RS-422
	Excitation voltage	8 ... 36 V DC
	Excitation current	19 mA typical at 24 V DC 35 mA typical at 12 V DC max. 80 mA
	Clock frequency	100 kHz ... 500 kHz
	Code	Gray-Code, continuous progression
	Delay between pulse trains ( $t_p$ )	30 $\mu$ s min.
	Stability (temperature)	$\pm 50 \times 10^{-6} / ^\circ\text{C}$ f.s. (typical)
	Operating temperature	See specification of the respective sensor
	Protection	Reverse polarity, short circuit
	EMC	DIN EN 61326-1:2013

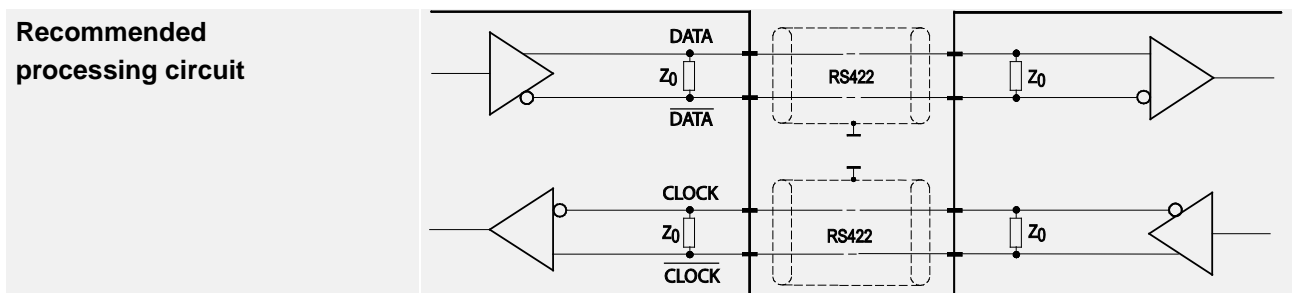
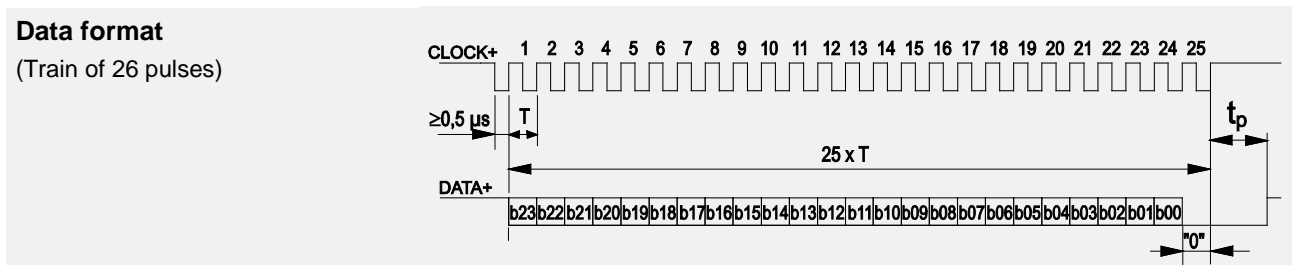

Transmission rate	Cable length	Baud rate
	50 m	100-400 kHz
	100 m	100-300 kHz

**Note:**  
Extension of the cable length will reduce the maximum transmission rate.

**Signal wiring**

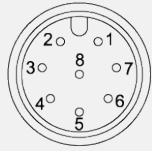
Signal	Connector pin no.	Cable color	View to sensor connector
Excitation +	1	white	
Excitation GND	2	brown	
CLOCK	3	green	
$\overline{\text{CLOCK}}$	4	yellow	
DATA	5	grey	
$\overline{\text{DATA}}$	6	pink	
-	7	blue	
-	8	red	

## Magnetic encoder, digital output CANopen

<b>MCANOP, CANOPR</b> CANopen 	CAN specification	ISO 11898, Basic and Full CAN 2.0 B
	Communication profile	CANopen CiA 301 V 4.02, Slave
	Encoder profile	Encoder CiA 406 V 3.2
	Error Control	Node Guarding, Heartbeat, Emergency Message
	Node ID	Adjustable via LSS or SDO, default: 127
	PDO	3 TxPDO, 0 RxPDO, no linking, static mapping
	PDO Modes	Event-/Time triggered, Remote-request, Sync cyclic/acyclic
	SDO	1 Server, 0 Client
	CAM	8 cams
	Certified	Yes
	Transmission rate	50 kBit bis 1 Mbit, adjustable via LSS or SDO, default: 125 kBit
	Bus connection	M12 connector, 5 pin
	Integrated bus terminating resistor	120Ω adjustable by the customer
	Bus, galvanic isolated	no

<b>Specifications</b>	Excitation voltage	8 ... 36 V DC
	Excitation current	20 mA typical at 24 V DC 40 mA typical at 12 V DC 80 mA max.
	Measuring rate	1 kHz (asynchronous)
	Stability (temperature)	±50 x 10 <sup>-6</sup> /°C f.s. (typical)
	Repeatability	1 LSB
	Operating temperature	See specification of the respective sensor
	Protection	Reverse polarity, short circuit
	Dielectric strength	1 kV (V AC, 50 Hz, 1 min.)
	EMC	EN 61326-1:2013

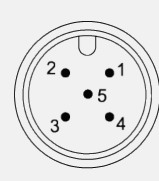
Signal wiring	Signal	Connector pin no.	View to the sensor connector
	Shield	1	
	Excitation +	2	
	GND	3	
	CAN-H	4	
	CAN-L	5	



## Magnetic encoder, digital output CAN SAE J1939

<b>MCANJ1939/R</b> CAN SAE J1939 	CAN Specification	ISO 11898, Basic and Full CAN 2.0 B
	Transceiver	24V-compliant, not isolated
	Communication profile	SAE J1939
	Baud Rate	250 kbit/s
	Internal termination resistor	120 Ω adjustable by the customer
	Address	Default 247d, configurable

<b>NAME Fields</b>	Arbitrary address capable	1	Yes
	Industry group	0	Global
	Vehicle system	7Fh (127d)	Non specific
	Vehicle system instance	0	
	Function	FFh (255d)	Non specific
	Function instance	0	
	ECU instance	0	
	Manufacturer	145h (325d)	Manufacturer ID
	Identity number	0nnn	Serial number 21 bit

<b>Parameter Group Numbers (PGN)</b>	Configuration data	PGN EF00h	Proprietary-A (PDU1 peer-to-peer)
	Process data	PGN FFnnh	Proprietary-B (PDU2 broadcast); nn Group Extension (PS) configurable

<b>Specifications</b>	Excitation voltage	8 ... 36 V DC
	Excitation current	20 mA typical at 24 V DC 40 mA typical at 12 V DC, max. 80 mA
	Measuring rate	1 kHz (asynchronous)
	Stability (temperature)	±50 x 10 <sup>-6</sup> /°C f.s. (typical)
	Repeatability	1 LSB
	Operating temperature	See specification of the respective sensor
	Protection	Reverse polarity, short circuit
	Dielectric strength	1 kV (V AC, 50 Hz, 1 min.)
EMV	EN 61326-1:2013	

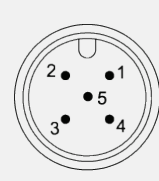
Signal wiring	Signal	Connector pin no.	View to the sensor connector
	Shield	1	
	Excitation +	2	
	GND	3	
	CAN-H	4	
	CAN-L	5	

## Incremental outputs

### Signal conditioner PP530

Incremental 	Excitation voltage	5 ... 30 V DC
	Excitation current	25 mA typ. (w/o load), 200 mA max.
	Output frequency	200 kHz max.
	Output	Linedriver, Push-Pull, CMOS, TTL and HTL compatible
	Output current	30 mA max.
	Output voltage	Depends on the excitation voltage
	Saturation voltage high/low	$I_a < 10 \text{ mA}, U_b 5 \text{ V}/24 \text{ V}: < 0,5 \text{ V}$ $I_a < 30 \text{ mA}, U_b 5 \text{ V}/24 \text{ V}: < 1 \text{ V}$
	Stability (temperature)	$\pm 20 \times 10^{-6} / ^\circ\text{C}$ f.s. (sensor mechanism)
	Operation temperature	-10 ... +70 °C
	Storage temperature	-30 ... +80 °C
	Transition time positive edge	< 200 ns
	Transition time negative edge	< 200 ns
	Protection	Reverse polarity, short circuit
	EMC	DIN EN 61326-1:2013

### Output signals

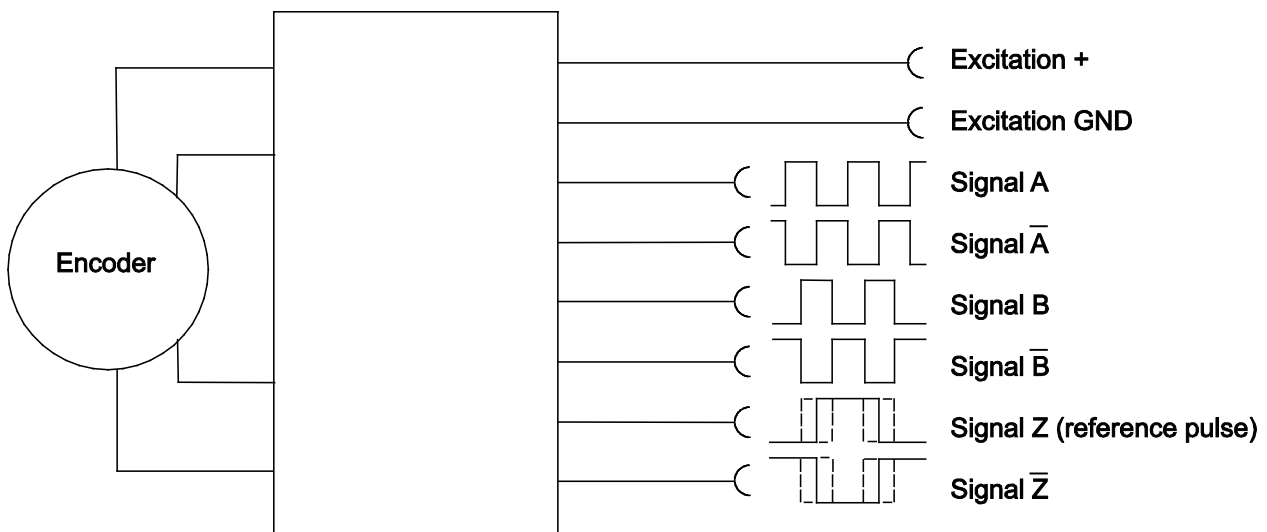

Recommended processing circuit

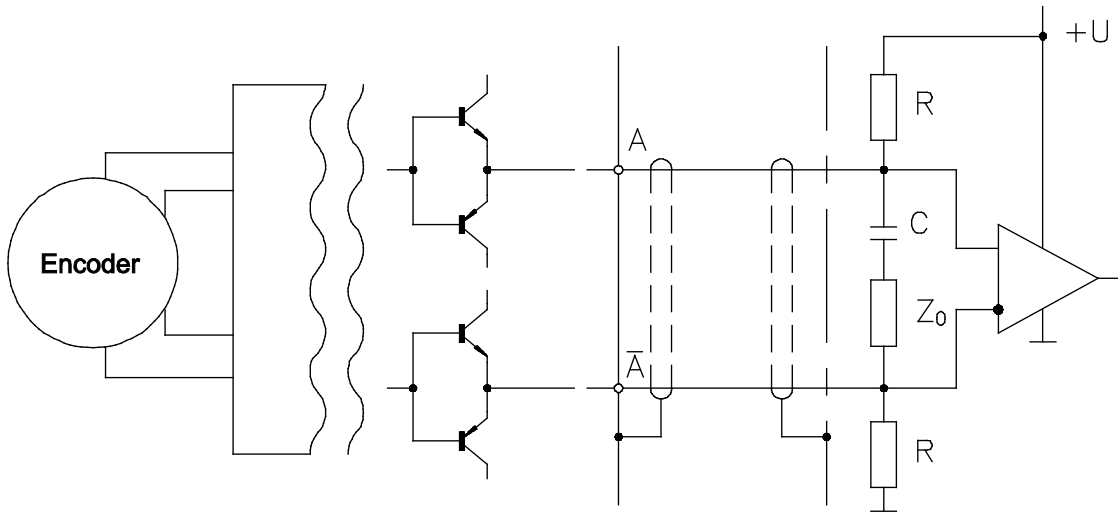

Signal wiring

Signal	Connector pin no.	Cable color	View to sensor connector
Excitation +	1	white	 <p>CONN-M12-8F</p>
Excitation GND	2	brown	
Signal A	4	yellow	
Signal $\bar{A}$	6	pink	
Signal B (A + 90°)	3	green	
Signal $\bar{B}$	5	grey	
Signal Z (reference pulse)	7	blue	
Signal $\bar{Z}$	8	red	

**Signal conditioner IE41LI and IE41HI**

Incremental 		<b>IE41LI</b>	<b>IE41HI</b>
	Excitation voltage	5 V DC ±10 %	10 ... 30 V DC
	Excitation current	150 mA max. (w/o load)	
	Output frequency	300 kHz max.	200 kHz max.
	Output	RS422	Push-pull antivalent
	Output current	±30 mA max.	30 mA
	Output voltage	Depending on the excitation voltage	
	Stability (temperature)	±20 x 10 <sup>-6</sup> / °C f.s. (sensor mechanism)	
	Operating temperature	-10 ... +70 °C	
	Protection against short circuit	One channel for 1 s	yes
EMC	DIN EN 61326-1:2013		

**Signal wiring WS10**

Signal	Connector pin no.	Cable color	View to sensor connector
Excitation +	1	white	 CONN-M12-8F
Excitation GND	2	brown	
Signal A	4	yellow	
Signal $\bar{A}$	6	pink	
Signal B (A + 90°)	3	green	
Signal $\bar{B}$	5	grey	
Signal Z (reference pulse)	7	blue	
Signal $\bar{Z}$	8	red	

**Signal wiring WS12**

Signal	Connector pin no.	Cable color	View to sensor connector
Excitation +	1	white	 CONN-M12-8F
Excitation GND	2	brown	
Signal A	3	green	
Signal $\bar{A}$	5	grey	
Signal B (A + 90°)	4	yellow	
Signal $\bar{B}$	6	pink	
Signal Z (reference pulse)	7	blue	
Signal $\bar{Z}$	8	red	

**Recommended processing circuit**

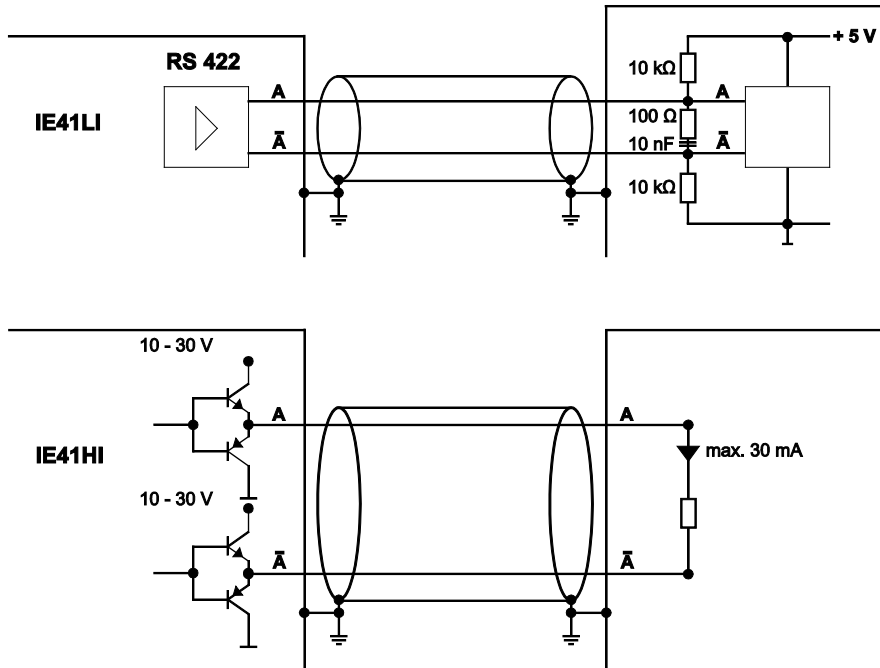

**Output signals**

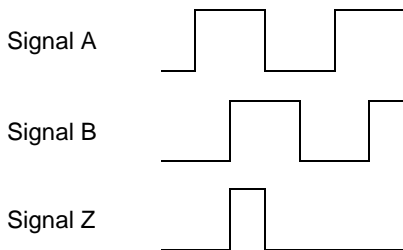

## Accessories

### Connector cable M12, 4 pin (angular coupling)

shielded connector

Suitable for 5-pin  
sensor connectors

The 4-core screened cable is supplied with a mating 4-pin 90° M12 connector at one end and 4 wires at the other end. Available lengths are 2 m, 5 m and 10 m. Wire: cross sectional area 0.34 mm<sup>2</sup>  
Cable diameter: 5.6 ±0.2 mm

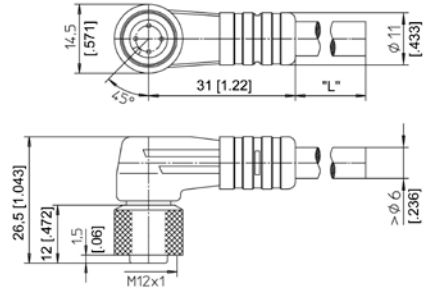

#### Order code

**KAB - xM - M12/4F/W - LITZE**

IP69: **KAB - xM - M12/4F/W/69K - LITZE**

xM = length in m

### Connector cable M12, 4 pin (straight coupling)

shielded connector

Suitable for 5-pin  
sensor connectors

The 4-core screened cable is supplied with a mating 4-pin M12 connector at one end and 4 wires at the other end. Available lengths are 2 m, 5 m and 10 m. Wire: cross sectional area 0.34 mm<sup>2</sup>  
Cable diameter: 5.6 ±0.2 mm

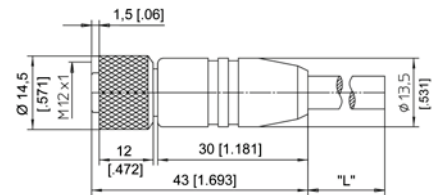

#### Order code

**KAB - xM - M12/4F/G - LITZE**

IP69: **KAB - xM - M12/4F/G/69K - LITZE**

xM = length in m

Signal wiring	Plug connection / cable color			
	M12, 4 pin	1	2	3
	brown	white	blue	black

### Applicable for cable carriers

Maximum movement speed	3 m/s
Maximum acceleration	5 m/s <sup>2</sup>
Minimum bending radius	10 x cable diameter

**Connector cable M12, 5 pin  
(angular coupling)**

shielded connector

The 5-core screened cable is supplied with a mating 5-pin 90° M12 connector at one end and 4 wires at the other end. Available lengths are 2 m, 5 m and 10 m.  
Wire: cross sectional area 0.34 mm<sup>2</sup>  
Cable diameter: 5.6 ±0.2 mm

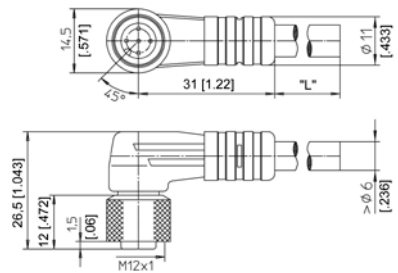

**Order code**

	<b>KAB - xM - M12/5F/W - LITZE</b>
IP69:	<b>KAB - xM - M12/5F/W/69K - LITZE</b>

xM = length in m

**Connector cable M12, 5 pin  
(straight coupling)**

shielded connector

The 5-core screened cable is supplied with a mating 5-pin M12 connector at one end and 4 wires at the other end. Available lengths are 2 m, 5 m and 10 m.  
Wire: cross sectional area 0.34 mm<sup>2</sup>  
Cable diameter: 5.6 ±0.2 mm

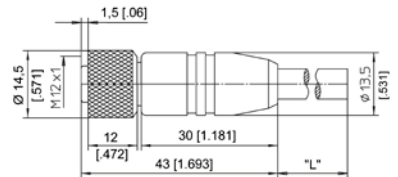

**Order code**

	<b>KAB - xM - M12/5F/G - LITZE</b>
IP69:	<b>KAB - xM - M12/5F/G/69K - LITZE</b>

xM = length in m

Signal wiring M12, 5 pin	Plug connection / Cable color				
	1	2	3	4	5
	brown	white	blue	black	grey

**Applicable for cable carriers**

Maximum movement speed	3 m/s
Maximum acceleration	5 m/s <sup>2</sup>
Minimum bending radius	10 x cable diameter

**Connector cable M12, 8 pin  
(angular coupling)**

shielded connector

The 8-lead shielded cable is supplied with a mating 8-pin 90° M12 connector at one end and 8 wires at the other end. Available lengths are 2 m, 5 m and 10 m. Wire: cross sectional area 0.25 mm<sup>2</sup> Cable diameter: 6.3 ±0.2 mm

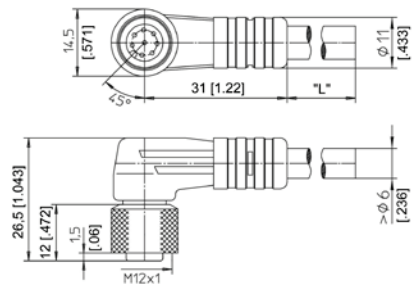

**Order code**

**KAB - xM - M12/8F/W - LITZE**

IP69: **KAB - xM - M12/8F/W/69K - LITZE**

xM = length in m

**Connector cable M12, 8 pin  
(straight coupling)**

shielded connector

The 8-lead shielded cable is supplied with a mating 8-pin M12 connector at one end and 8 wires at the other end. Available lengths are 2 m, 5 m and 10 m. Wire: cross sectional area 0.25 mm<sup>2</sup> Cable diameter: 6.3 ±0.2 mm

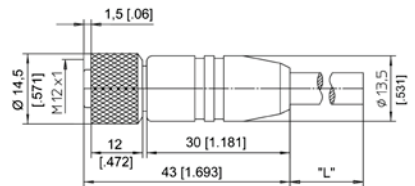

**Order code**

**KAB - xM - M12/8F/G - LITZE**

IP69: **KAB - xM - M12/8F/G/69K - LITZE**

xM = length in m

Signal wiring	Plug connection / cable color							
	1	2	3	4	5	6	7	8
M12, 8 pin	white	brown	green	yellow	grey	pink	blue	red

**Applicable for cable carriers**

Maximum movement speed	3 m/s
Maximum acceleration	5 m/s <sup>2</sup>
Minimum bending radius	10 x cable diameter



### Connector/bus cable M12, 5 pin CAN-Bus

The 5-lead shielded cable is supplied with a female 5 pin M12 connector at one end and a male 5 pin M12 connector at the other end.

Available lengths are 0.3 m, 2 m, 5 and 10 m.

Cable diameter: 6.7 ±0.2 mm

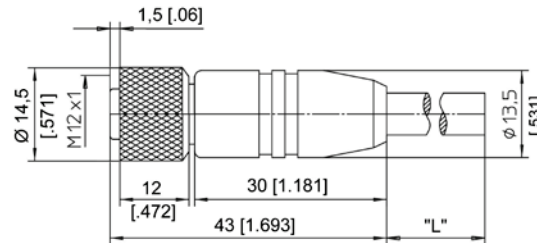

**Order code**

**KAB - xM - M12/5F/G - M12/5M/G - CAN**

IP69: **KAB - xM - M12/5F/G/69K - M12/5M/G/69K - CAN**

xM = length in m

### T-connector for bus cable M12, 5 pin CAN-Bus

**Order code**

**KAB - TCONN - M12/5M - 2M12/5F - CAN**



### Terminating resistor M12, 5 pin CAN-Bus

**Order code**

**KAB - RTERM - M12/5M/G - CAN**



**Applicable for cable carriers**

Maximum movement speed	3 m/s
Maximum acceleration	5 m/s <sup>2</sup>
Minimum bending radius	10 x cable diameter

**Plug-in connector M12, 8 pin (straight coupling)**

Order code:

**CONN-M12-8F-G**

Cable diameter  
max. 6 ... 8 mm

