

PMIS3 POSIMAG[®] Magnetic Scale Position Sensor



Very compact sensor for industrial applications Sensor head PMIS3

- Non-contact, no wear
- High velocity
- Robust shielded metal enclosure
- Protection class IP67
- Incremental encoder output A/B/Z
- Signal processing as usual with encoders
- Reference pulse and end position signal
- Indicator for velocity/position errors

A POSIMAG measuring system consists of the sensor head PMIS3 and the magnetic scale PMIB3 with the same magnetic period.

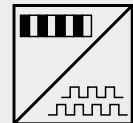

Specifications	Output	
		Incremental encoder output A/B with differential push-pull output, TTL/RS422 or HTL compatible
Excitation voltage	10 ... 30 VDC or 5 VDC ±5 %	
Excitation current	50 mA to 300 mA, depending on pulse frequency, cable length and load	
Magnetic period of the sensor	2 mm	5 mm
Guided spacing between sensor and mag. scale (x ₂)	0.1 ... 0.8 mm	0.1 ... 2 mm
Side tracking tolerance of the sensor	±1 mm	±1 mm
Linearity (sensor with mag. scale PMIB3)	15 µm ± 40 µm/m	30 µm ± 40 µm/m
Repeatability	± 1 digit	
Resolution with ext. times 4 counting mode [µm]	5 10 20 50	10 25 50 125
Max. velocity with fp=50 kHz [m/s] (20 kHz: x 0.4; 10 kHz: x 0.2)	0.8 1.6 3.2 8	1.6 4 8 20

Order code PMIS3



Model name

Magnetic period

20 = 2 mm / 50 = 5 mm

Resolution (in µm) with times 4 counting mode

Mag. period 2 mm: 5 / 10 / 20 / 50

Mag. period 5 mm: 10 / 25 / 50 / 125

Max. pulse frequency (in kHz, standard 50 kHz)

50 / 20 / 10

Output

HTL = HTL output with excitation 24 VDC, output 24 V

TTL = TTL output with excitation 5 VDC, output TTL/RS422

TTL24V = TTL output with excitation 24 VDC, output TTL/10 mA

Reference pulse/ end position signal/ status signal

Z0 = A/B w/o reference pulse / Z1 = A/B with reference pulse Z

Z2 = A/B with end position signal / *Z3 = A/B with reference pulse

and status signal

(Option Z3 only for non-differential output, single ended)

Cable length (in m, standard 2 m)

Connection

S = Cable output, open end

P / P15 = SUB-D connector at the cable end: P = 9 pins; P15 = 15 pins

Order example: PMIS3 - 50 - 25 - 50KHZ - HTL - Z1 - 2M - S

PMIS3 POSIMAG[®] Magnetic Scale Position Sensor



Specifications (continued)	Max. pulse frequency f_p	50 kHz, 20 kHz, 10 kHz (standard 50 kHz)
	Outputs	A, \bar{A} , B, \bar{B} , reference pulse Z , \bar{Z} , end position signal E, \bar{E} , status signal ERR
	Material of enclosure	Zinc die casting
	Electrical connection	Cable 8 wire, \varnothing 5 mm, open cable end, 9 pin SUB-D connector at the cable end as option. Max. length of the integrated sensor cable for TTL: 3 m; HTL/TTL24V: 20 m
	Weight (w/o cable and connector)	30 \pm 5 g
	Protection class (EN 60529)	IP67
	Environmental	
	Shock	EN 60068-2-27:1993, 50 g 6 ms, 100 shocks
	Vibration	EN 60068-2-6:1995, 20 g, 10-2000 Hz, 10 cycles
	EMC	DIN EN 61326
Temperature	-40 ... +85°C	



The subsequent counting device must be able to process the specified maximum pulse frequency of the sensor.

Output signals	Saturation voltage	UH, UL = 0,2 V UH, UL = 0,4 V $C_{last} < 10$ nF	$I_{out} = \pm 10$ mA (UH = UB - U _{out}) $I_{out} = \pm 30$ mA
	Short circuit current	ISL, ISH < 800 mA ISL, ISH < 90 mA	(UH, UL = 0 V) (UH, UL = 1,5 V)
	Rise time	$t_r, t_f < 200$ ns	with cable length 1 m, 10 % ... 90 %

Pulse frequency in dependence on the cable length	Load/cable length	Load/pulse frequency f_p		
		HTL single ended UB = 24 V	TTL/RS422 differential UB = 5 V *	TTL/24 V UB = 24 V
	Max. output current	50 mA	50 mA	10 mA
	R_{last} min.	500 Ω	100 Ω	500 Ω
	C_{last} max.	10 nF	10 nF	1 nF
	200 m	15 kHz	—	—
	100 m	25 kHz	100 kHz	—
	50 m	50 kHz	200 kHz	50 kHz
	10 m	100 kHz	300 kHz	100 kHz

* = consider the voltage loss of the cable; the excitation voltage 5 V \pm 5% of the sensor must be guaranteed.

Note: For longer distances (see specification above) you must use min. 0,5 mm² wire for „Excitation+“ and „Excitation GND“ (see signal wiring next page), all signal wires must be min. 0,14 mm²!

Outline drawing

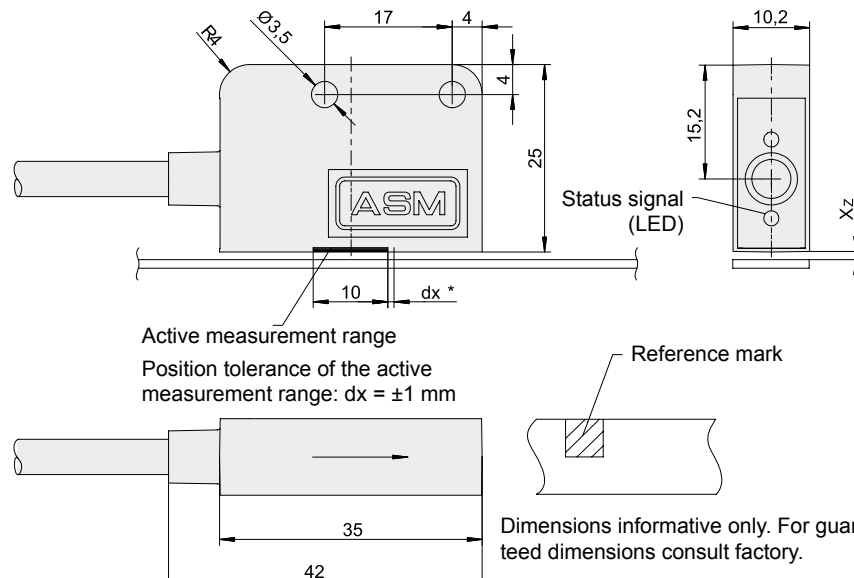

PMIS3 POSIMAG[®] Magnetic Scale Position Sensor



Output signals

Option Z1 (Reference pulse)

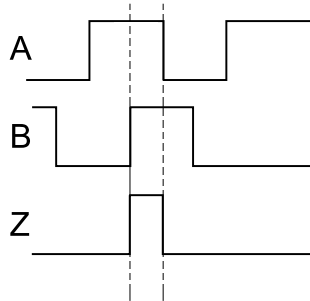

Option Z2 (End position signal)

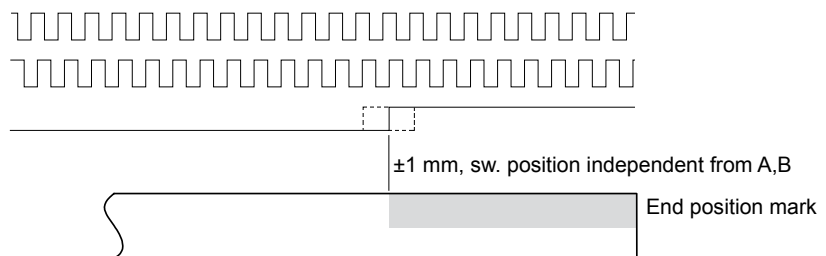

Signal wiring / connection	Signal name					Open cable end Cable colour	Conn. SUB-D, 9 pin pin no.
	Option	Z0	Z1	Z2	Z3*		
Excitation +						white	1
Excitation GND (0V)						brown	5
		B	B	B	B	green	2
		A	A	A	A	yellow	3
		\overline{B}	\overline{B}	\overline{B}	ERR	grey	7
		\overline{A}	\overline{A}	\overline{A}	-	pink	6
		-	Z	\overline{E}	Z	blue	4
		-	\overline{Z}	E	-	red	8
Shield						black	9

- Z = reference pulse
- E = end position signal
- ERR = status signal, periodical approx. 16 Hz, for side tracking and velocity errors
- * = status signal \overline{ERR} available only with HTL (single ended) output

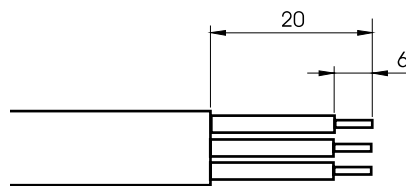

Cable output dimensions

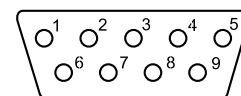

Connector SUB-D (Pin)
View to connector pins

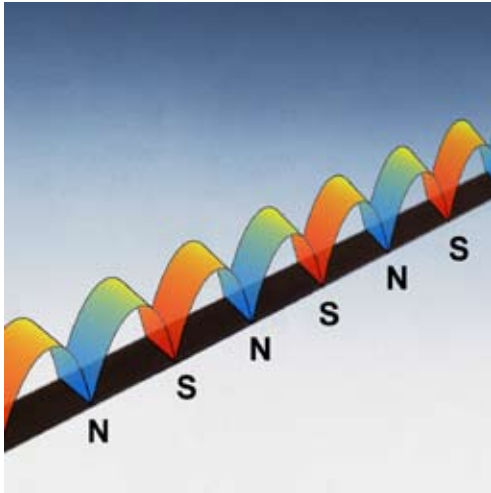

Magnetic scale PMIB3 for Position Sensor PMIS3

- Easy splicing
- Resistant to moisture and many fluids
- Extensive ruggedness against dust etc.
- High temperature durability
- Magnetic scale with stainless steel base

The magnetic material is magnetised in defined and even distances and works as a solid measure. Reference marks can be user defined in 4 mm resp. 10 mm steps. The magnetic scale retains its firmness by means of a spring steel base (stainless steel strip CrNi 17 7).

Specifications

Solid measure	Plastic bonded flexible permanent magnet		
Base material	Stainless steel CrNi 17 7 / elastomer		
Masking tape	Stainless steel (non magnetic)		
Measurement ranges	e.g. 100 ... 2500 mm (up to 50 m on request)		
Width	10 mm +0.1 mm / -0.2 mm		
Thickness (w/o masking tape)	1.4 mm +0.1 mm / -0.2 mm		
Thickness (with masking tape)	1.6 mm +0.1 mm / -0.2 mm		
Magnetic period	2 mm		5 mm
Linearity at 25°C	up to 30 m	±40 µm/m	±40 µm/m
	up to 50 m	±80 µm/m	±80 µm/m
Reference mark (reference pulse)	max. every 4 mm		max. every 10 mm
Measurement range	must be divisible by 4		must be divisible by 10
Linear thermal expansion coefficient	17 x 10 ⁻⁶ / K		
Operating temperature	-40 ... +100°C		

An unmagnetic masking tape made of stainless steel is available (accessories). The magnetic scale is flexible and can be glued to the surface of a cylinder with a minimum radius of 100 mm and used for angular measurements.

Order code PMIB3

PMIB3 - [] - [] - [] - [] - []

Model name

Magnetic period

20 = 2 mm / 50 = 5 mm

Mounting of the magnetic scale

N = adhesive taping

Measurement range (total length = range + X mm, refer to the table on page 10)

e.g. 100, 500, 1000 ... 2500 mm (up to 50 m on request)

Measurement ranges must be divisible by 4 (resp. by 10)

Reference marks/end position marks (optional)

R1 = reference mark on the left / R2 = on the right

E1 = end position mark on the left / E2 = on the right

Additional reference marks every 4 mm (period 2 mm) resp. 10 mm (period 5 mm) from the left

Options

FP = magnetic scale in flat profile

HP = magnetic scale in high profile

AB = masking tape (only with FP + HP)

Order example: PMIB3 - 50 - N - 1500 - R1

PMIS3/PMIB3 POSIMAG® Magnetic Scale



Position of the standard reference marks

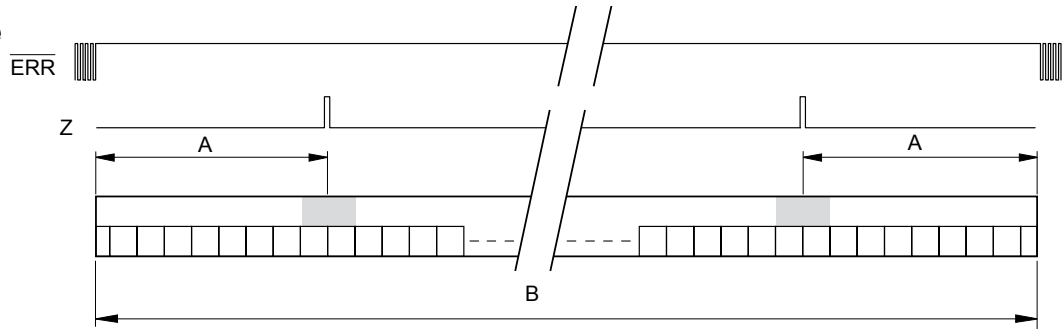

Dimensions reference	Magnetic period	Switching position A	Total length B
	2 mm	20.0 ±1 mm	measurement range + 40 mm
	5 mm		
	2 mm with high profile	60.0 ±1 mm	measurement range + 120 mm
	5 mm with high profile		

Additional reference marks every 4 mm (period 2 mm) resp. 10 mm (period 5 mm) from the left h. s.

Position of the end position marks

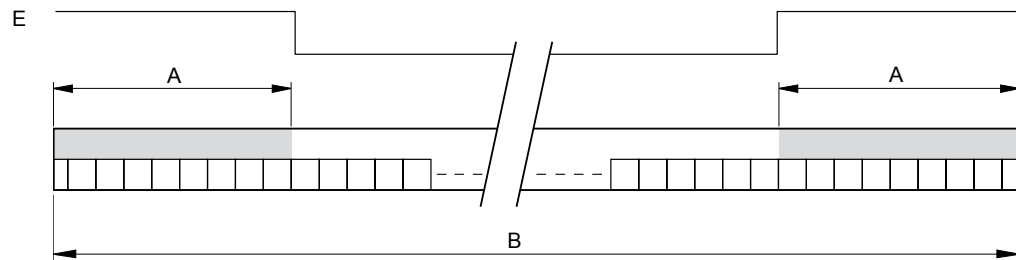

Dimensions end positions	Magnetic period	Switching position A	Total length B
	2 mm	21.0 ±1 mm	measurement range + 50 mm
	5 mm	22.5 ±1 mm	measurement range + 50 mm
	2 mm with high profile	61.0 ±1 mm	measurement range + 130 mm
	5 mm with high profile	62.5 ±1 mm	measurement range + 130 mm

PMIS3/PMIB3 POSIMAG®

Magnetostrictive Position Sensor

Accessories



Masking tape PMAB:

Masking tape made of stainless steel for POSIMAG magnetic scale PMIB3, width 10 mm, thickness 0.2 mm

Order code: PMAB — 10MM —
 Length in mm

Outline drawing flat profile PMFP

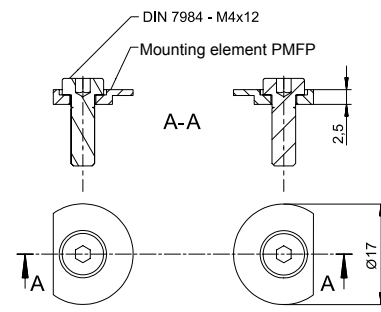
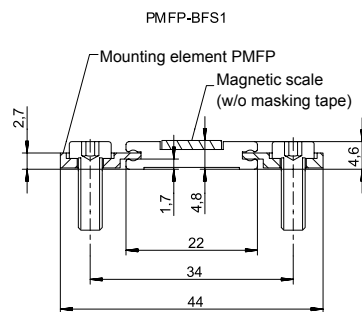

Mounting set PMFP-BFS1

Outline drawing high profile PMHP

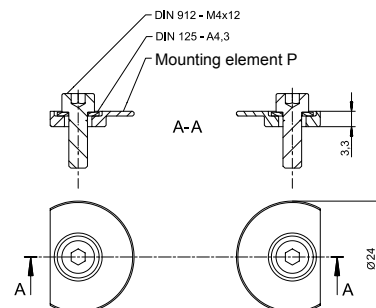
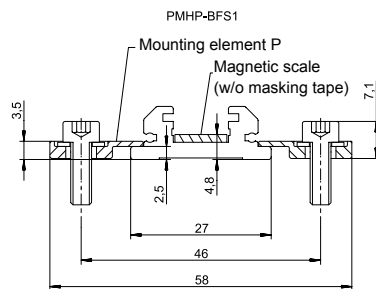

Mounting set PMHP-BFS1

Slider for high profile PMGW3

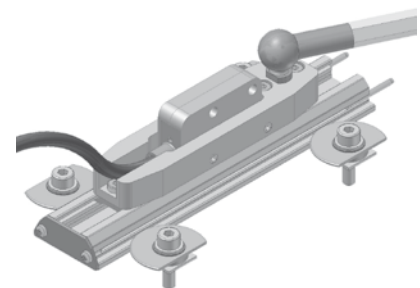
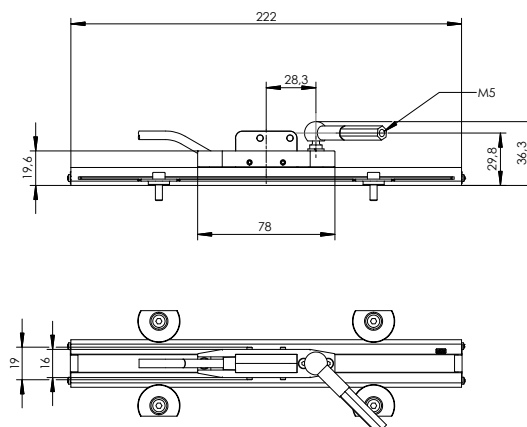

Dimensions informative only. For guaranteed dimensions consult factory.

Magnetic Scales – Technical Information

Types of magnetic scales / Application recommendation

Type	Stainless steel elastomer scale PMIB3
base strip	CrNi 17 7 stainless steel
magnetic scale	Elastomer magnetic scale
environmental conditions	very difficult
corrosion resistance	high
temperature resistance	high
media resistance	high

Chemical durability – Elastomer magnetic scales (PMIB3)

no / little influence	weak / middle influence	strong influence
motor oils gear oils ATF (automatic transmission fluid) hydraulic fluid kerosene antifreeze agent purifying agent turpentine water sea water/salt water	JP-4 fuel (Jet fuel) gasoline/petrol heptane alcohol	aromatic hydrocarbon (benzene, toluene, xylene) ketone anorganic acids (HCl, H ₂ SO ₄)