

T • Pressure Transmitters

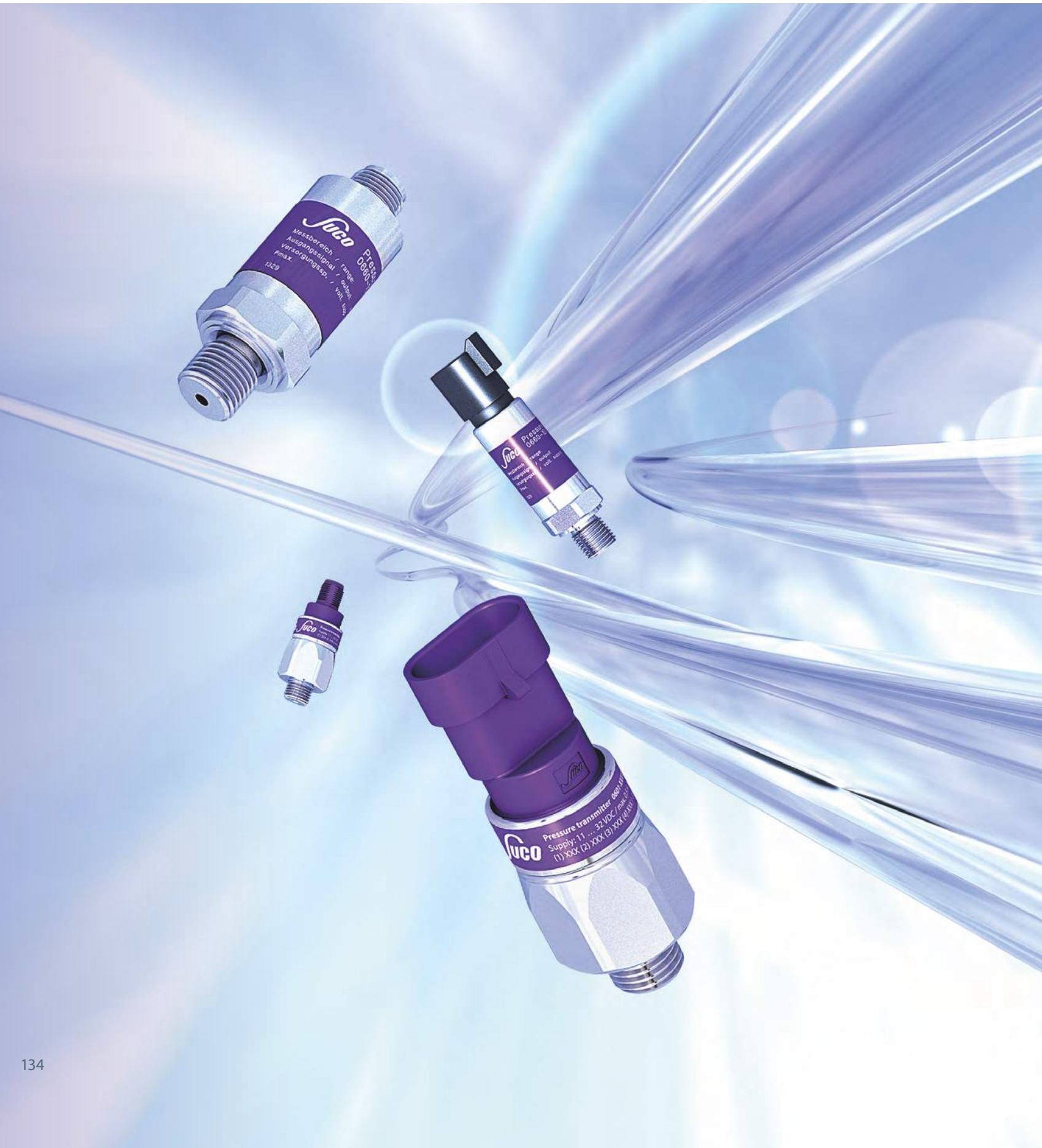

Pressure transmitters, High-Performance series

hex 22



- Outstanding overpressure protection (up to 4 x)
- Ideal choice for mobile hydraulic applications
- Long service life even under high pressure change rates
- Wetted parts made of stainless steel and titanium ensuring excellent media compatibility
- All welded design, no elastomeric seal
- Silicon-on-sapphire technology (SoS) for highest reliability, accuracy and reliable process monitoring
- Very low temperature error and very good long-term stability
- Customer specific solutions available on request

Technical details

Type:	0705	0710	0720
Output signal:	0.5 – 4.5 V ratiometric	0 – 10 V (3-wire)	4 – 20 mA (2-wire)
Supply voltage U_B :	5 VDC \pm 10 % max. 6.5 VDC	12 – 32 VDC	10 – 32 VDC
Permissible load apparent ohmic resistance:	$\geq 4.7 \text{ k}\Omega$	$\geq 4.7 \text{ k}\Omega$	$\leq (U_b - 10 \text{ V}) / 20 \text{ mA}$
Idle power consumption:	approx. 5 mA		

Type:	0705 / 0710 / 0720									
Standard pressure ranges p_{nom} in bar:	0–10	0–16	0–25	0–40	0–60	0–100	0–160	0–250	0–400	0–600
Overpressure protection $p_u^{1)}$ in bar:	40	64	100	160	240	400	640	1,000	1,600	1,650
Burst pressure ¹⁾ in bar:	80	128	200	320	480	800	1,280	2,000	2,000	2,000
Mechanical life expectancy:	10,000,000 pulsations at rise rates to 5 bar/ms at p_{nom}									
Permitted pressure change rate:	$\leq 5 \text{ bar/ms}$									
Accuracy:	$\pm 0.5 \%$ full scale (FS) at room temperature, $\pm 0.25 \%$ BFSL									
Long term stability:	$\pm 0.1 \%$ FS p. a.									
Repeatability ²⁾ :	$\pm 0.1 \%$ FS									
Temperature error ²⁾ :	$\pm 0.01 \%$ FS / °C									
Compensated temperature range:	-40 °C ... +80 °C (-40 °F ... 176 °F)									
Temperature range ambient:	-40 °C ... +100 °C (-40 °F ... 212 °F)									
Temperature range media:	-40 °C ... +125 °C (-40 °F ... 257 °F)									
Wetted parts material:	stainless steel 1.4305 / SAE Grade 303, titanium									
Insulation resistance:	$> 100 \text{ M}\Omega$ (500 VDC, $R_i > 42 \Omega$)									
Response time 10 – 90%:	$< 2 \text{ ms}$									
Vibration resistance:	20 g at 4 – 2000 Hz sine wave; DIN EN 60068-2-6									
Shock resistance:	half sine wave 500 m/s^2 ; 11ms; DIN EN 60068-2-27									
Protection class	IP67 for M 12x1, DIN 72585 (bayonet) and cable connector IP65 for DIN EN 175301-803									
Electromagnetic compatibility:	EMC 2014/30/EU, EN 61000-6-2, EN 61000-6-3									
Max. length of connection cable:	30 m									
Protection against reverse polarity, short-circuit and overvoltage:	Built-in									
Weight:	approx. 80 g (DIN 175301 approx. 110 g, cable outlet approx. 135 g)									

¹⁾ Static value. Dynamic value is 30 to 50% lower. Values refer to the hydraulic/pneumatic part of the pressure transmitter / transducer.

²⁾ Within the compensated temperature range.

T.4

hex 22
High-Performance

0705 / 0710 / 0720

Electrical connectors and threads



DIN EN 175301-803-A

0705 + 0710	0720
1: U _{out}	1: nc
2: Gnd	2: I _{out}
3: Uv+	3: Uv+
IP65	
x ~ 60 / 76 mm*	
d ~ Ø 30 mm	
Order number: 001	

M 12 – DIN EN 61076-2-101 A

0705 + 0710	0720
1: Uv+	1: Uv+
2: U _{out}	2: nc
3: Gnd	3: I _{out}
4: nc	4: nc
IP67	
x ~ 54 mm	
d ~ Ø 22 mm	
Order number: 002	

ISO 15170-A1-4.1

0705 + 0710	0720
1: Uv+	1: Uv+
2: Gnd	2: nc
3: U _{out}	3: I _{out}
4: nc	4: nc
IP67, IP6K9K	
x ~ 65 mm	
d ~ Ø 27 mm	
Order number: 004	

AMP Superseal

0705 + 0710	0720
1: U _{out}	1: nc
2: Gnd	2: I _{out}
3: Uv+	3: Uv+
IP67	
x ~ 73 mm	
d ~ Ø 26 mm	
Order number: 007	

* without coupler socket x ~ 60 mm, with coupler socket x ~ 76 mm

DEUTSCH DT04-4P

0705 + 0710	0720
1: Gnd	1: I _{out}
2: Uv+	2: Uv+
3: nc	3: nc
4: U _{out}	4: nc
IP67, IP6K9K	
x ~ 74 mm	
d ~ Ø 23 mm	
Order number: 008	

DEUTSCH DT04-3P

0705 + 0710	0720
A: Uv+	A: Uv+
B: Gnd	B: nc
C: U _{out}	C: I _{out}
IP67, IP6K9K	
x ~ 74 mm	
d ~ Ø 23 mm	
Order number: 010	

Cable connection

0705 + 0710	0720
1: Uv+	1: Uv+
2: U _{out}	2: nc
3: Gnd	3: I _{out}
IP67	
x ~ 44 mm (+ 20 mm bend relief) Cable length ~ 2 m	
d ~ Ø 22 mm	
Order number: 011	

Viton®-Sealing ring
G 1/4 DIN EN ISO 1179-2 (DIN 3852-11) form E

Thread code: 41

G1/4 DIN 3852-A

Thread code: 03

NPT 1/8

Thread code: 04

NPT 1/4

Thread code: 09

M 10x1 DIN 3852-A

Thread code: 30

7/16-20 UNF

Thread code: 20

9/16-18 UNF

Thread code: 21

Viton®-Sealing ring
M14x1,5 DIN EN ISO 9974-2 (DIN 3852-11) form E

Thread code: 42



0705 / 0710 / 0720

Order matrix for pressure transmitters

T.4

hex 22
High-Performance



	Type	Pressure range	Pressure connection	Seal material	Electrical connection
	↓	↓	↓	↓	↓
0.5 – 4.5 V, ratiometric	0705				
0 – 10 V, 3-wire	0710				
4 – 20 mA, 2-wire	0720				

Pressure range	Max. overpressure ¹⁾	
0 – 10 bar (approx. 145 PSI)	40 bar	101
0 – 16 bar (approx. 232 PSI)	64 bar	161
0 – 25 bar (approx. 362 PSI)	100 bar	251
0 – 40 bar (approx. 580 PSI)	160 bar	401
0 – 60 bar (approx. 870 PSI)	240 bar	601
0 – 100 bar (approx. 1,450 PSI)	400 bar	102
0 – 160 bar (approx. 2,320 PSI)	640 bar	162
0 – 250 bar (approx. 3,620 PSI)	1000 bar	252
0 – 400 bar (approx. 5,800 PSI)	1600 bar	402
0 – 600 bar (approx. 8,700 PSI)	1650 bar	602

Pressure connection	
G 1/4 – DIN 3852-E	41
G 1/4 – DIN 3852-A	03
NPT 1/8 (max. to 250 bar)	04
NPT 1/4	09
M 10 x 1 cyl. DIN 3852-A (max. to 250 bar)	30
7 / 16 – 20 UNF (max. to 250 bar)	20
9 / 16 – 18 UNF	21
M 14 x 1.5 – DIN 3852-E	42

Pressure unit	
bar	B
PSI	P

Electrical connection	
DIN EN 175301-803-A (DIN 43 650-A) ; socket device included	001
M 12 – DIN EN 61071-2-101 D	002
Bayonet ISO 15170-A1-4.1 (DIN 72585-A1-4.1)	004
AMP Superseal 1,5°	007
Deutsch DT04-4P	008
Deutsch DT04-3P	010
Cable connection (length of cable 2 m standard)	011

Order number:	07XX	XXX	XX	X	XXX
----------------------	-------------	------------	-----------	----------	------------

¹⁾ Static pressure, dynamic pressure 30 to 50% lower. Values refer to the hydraulic or pneumatic part of the pressure transmitter.



T

General technical explanations

User information

Our pressure monitoring products may only be installed and started up by authorised specialists. The safety regulations of country-specific authorities must be observed, especially when working with mains voltages and oxygen, and in potentially explosive areas.

Product information

The technical information in this catalogue is based upon fundamental testing during product development and empirical values. The information cannot be used for all application scenarios.

Testing of the suitability of our products for a specific application (such as the checking of material compatibilities) remains the responsibility of the user. It may be the case that suitability can only be verified by appropriate field testing.

IP protection class

The IP protection class is a defined protection level code (sealing) of electrical equipment housings in line with IEC 60529 (formerly DIN 40050 – Part 2). Protection of a housing against the following is tested here:

- The penetration of solid extraneous particles, such as dust
- Access of hazardous parts
- Penetration of water

IP protection tests are performed as type tests. The IP protection type code, made up of two digits, specifies the protection of a housing against the penetration of solid extraneous particles and water. The numeric code therefore provides conclusions to be drawn on the level of personal safety as well as the functional protection / mid to long-term functional reliability of electrical equipment.

Protection types IP00, IP65, IP67 and IP6K9K

IP00:

No protection against penetration of solid particles or water, no protection against contact.

IP6X:

Protection against penetration of dust (dust proof). Full contact protection.

IPX5:

A jet of water from a nozzle, aimed at equipment (such as a pressure switch) from all directions, must not have any harmful effect.

IPX7:

Protection from water, when equipment (such as a pressure switch) is immersed in water under defined pressure and time conditions. Water must not penetrate into the equipment in harmful quantities.

IP6K9K:

Devices satisfying these requirements must be dust-proof and be able to withstand loads during the use of high-pressure cleaners and steam jets. The standard stipulates a water pressure from 80 to 100 bar at a temperature of 80°C for testing.

IP6KX:

Dust must not penetrate. Letter K: Specific to the electrical equipment of road vehicles.

IPX9K:

Protection against penetration of water at high pressure / for steam jet cleaning. Water aimed at the housing from every direction at greatly increased pressure may not have any damaging effects.

We are able to offer IP67 / IP6K9K for many of our mechanical and electronic pressure switches (pre-wired or with integrated connector) and for our transmitters.

IP67 / IP6K9K is the recommended protection for mobile hydraulics and any equipment exposed to the outdoor environment.

Cylindrical threads

Cylindrical threads are either sealed on the front by underlaying an appropriate sealing ring (such as a copper sealing ring) or by already having integrated O-rings or gaskets.

Conical threads (cone-shaped threads)

Conical threads guarantee tolerance compensation of the two threaded parts. The sealing function is realised with thread flanks which deform permanently and enter into a metallic frictional fit. Conical threads are not screwed in down to the screw-in depth, but fixed with the tightening torque required for the leak tightness. Remember not to exceed the permitted tightening torque of the pressure switch or transmitter presented in the following table (to prevent damaging the threaded pin beforehand, causing it to become untight during operation or to snap off when tightened).

Tightening torques of steel threads

The specifications below are to be understood upper material thresholds for the housing of pressure switches or transmitters. Remember during installation that the type and material of the seal, the condition of mating surfaces (e.g. dry or oily) and the material of the counter-piece all have a bearing on the tightening torque.

Thread	Tightening torque
NPT 1/8; M 10 x 1 conical	max. 18 Nm
M 10 x 1 cyl.; G 1/8	max. 20 Nm
M 12 x 1.5; 7/16 – 20 UNF	max. 30 Nm
G 1/4; 9/16 – 18 UNF	max. 40 Nm
NPT 1/4; M 14 x 1.5	max. 40 Nm

Brass housing

Values 30% lower than in the table above must be used for brass housings.

Gaseous applications

Using additional sealant to attain the required leak tightness may be necessary for gas applications.

Vacuum

The values given in the technical details for the vacuum range are specified in millibars (mbar) below atmospheric pressure.

Pressure change rate (~rise / ~fall)

The pressure change rate denotes the pressure over time for the rising/falling pressure. The pressure change rate is specified in bar/s or bar/ms.

The maximum pressure change rate for SUCO mechanical pressure switches is 1 bar/ms (1,000 bar/s). For SUCO electronic pressure monitoring products the maximum pressure change rate can be up to 5 bar/ms (5,000 bar/s).

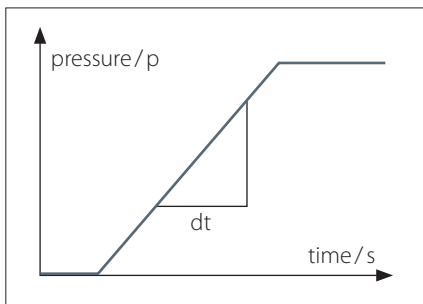

Over pressure protection

The specified over pressure protection in the catalogue is based on a static pressure. The values refer to the hydraulic or pneumatic part of the switch.

It is best practice to use 30 - 50% lower values for dynamic pressure compared to static pressure. These empirical values are based on the knowledge that, in pressure systems, unexpected pressure peaks which are higher than the working pressure are generated as a result of activation of valves, sudden falling or rising load or simply the change of cross-sections in the pipes. With conventional measurement techniques (such as manometers), these pressure peaks are hardly measurable. Faster measurement systems must therefore be used for this data acquisition. Attempts are being made to take this into account by using empirical or corrective factors.

If the pressure conditions are known and the pressure change rates are ≤ 0.1 bar/ms, our pressure switches and transmitters can be used up to the permitted overpressure protection as per data sheet / catalogue. Only 50% of the specified overpressure protection is permitted when operating at the maximum permitted pressure change rate of ≤ 1 bar/ms for mechanical pressure switches, and at ≤ 5 bar/ms for transmitters.

RoHS-Compliance

RoHS
= **R**estriction of **H**azardous **S**ubstances
(EC Directive 2011/65/EU (RoHS II))



CE mark

European Parliament and Council directives must be observed when products are launched onto the market. If a directive exists for a product, it must be applied. Only products for which a directive exists may bear the CE mark.

Mechanical pressure switches with a supply voltage above 50 VAC or 75 VDC are covered by the 2014/35/EU Low Voltage Directive. Variants for potentially explosive areas are covered in addition by the 2014/34/EU ATEX Product Directive.

Our electronic products satisfy EMC (Electromagnetic Compatibility) Directive 2014/30/EC.

Mechanical pressure switches do not fall under the EMC Directive.

The Machinery Directive 2006/42/EC is not applicable, because our products are classed as components.

Our product designs are based upon "good engineering practise" in line with Article 4, Paragraph 3 of the Pressure Equipment Directive (2014/68/EU), meaning neither a declaration of conformity may be issued nor a CE mark affixed.

The current product-specific CE declaration is available for download from the download area on our homepage:
www.suco.de/Downloads.htm



Subject to technical changes.

Technical explanations for pressure transmitters

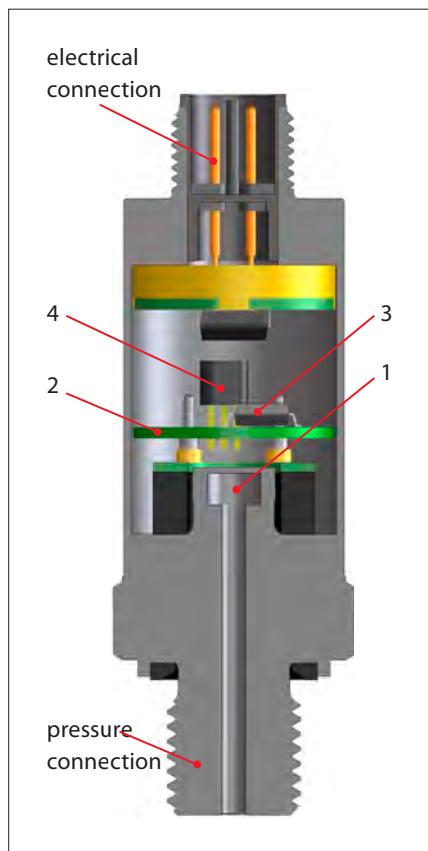

What is a pressure transmitter?

A pressure transmitter (also called pressure transducer or pressure converter) is a component used to convert a pneumatic or hydraulic pressure to an electric (usually analogue and linear) output signal, such as a current or voltage.

How does a pressure transmitter work?

The pressure measuring cell fitted has a membrane (1) that is exposed to the pressure to be measured. Affixed on this membrane is a bridge circuit consisting of four ohmic resistors in the form of a Wheatstone bridge. The values of these resistors change proportionally to the pressure load present at the measuring cell or membrane. The bridge voltage of the measuring cell is amplified in the evaluation electronics (2) and processed digitally by a microcontroller (3).

The downstream output stage (4) converts this signal to the output signal required (such as 4 - 20 mA or 0 - 10 V).

Block diagram:

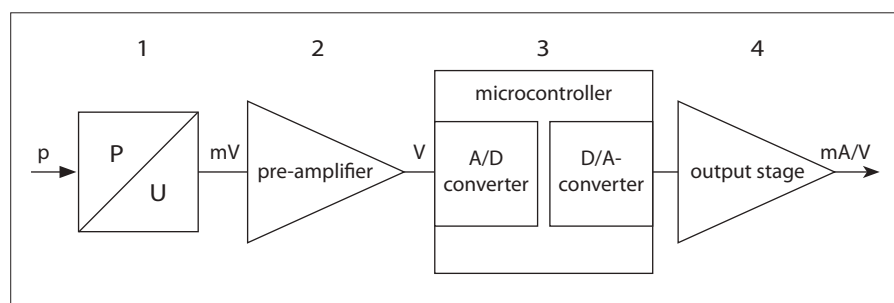

SoS technology

In the silicone-on-sapphire technology, the substrate of the thin film measuring cell is synthetic sapphire. This has excellent mechanical and temperature stable properties and prevents undesired parasitic effects, thereby having a positive effect on accuracy and stability. In conjunction with a titanium membrane, this results in virtually unique coaction between the temperature coefficients of sapphire and titanium.

This is because, unlike silicon and stainless steel, they are more closely matched and so only require a low level of compensation overhead. This also has a favourable effect on long-term stability.

"Oil-filled" stainless steel measuring cell

In this measuring cell technology, the piezoresistive measuring cell is packaged within a metallic housing filled with fluorine oil. This means the measuring cell is virtually free of external mechanical stress. Fluorine oil has excellent characteristics in regards to temperature and ageing behaviour, and is not flammable and so fits perfectly to oxygen applications. It is not recommended for food applications.

Ceramic measuring cell / thick film technology

Ceramic thick film pressure measuring cells are made up of a sintered ceramic body. The ceramic body sleeve already has the key geometries for the subsequent pressure range. The membrane thickness required and thus, the pressure range required is established with grinding and lapping. The resistors are imprinted with thick film technology and interconnect to form a measuring bridge.

Standard signals

Output signals 4 - 20 mA, 0 - 10 V and 0.5 - 4.5 V ratiometric in particular have established themselves in the industry. SUCO also offers transmitters with customer-specific output signals (such as 1 - 5 V).

Voltage output 0 - 10 V

Transmitters with an output signal of 0 to 10 V are a commonly used variant due to their simple initial operation and straightforward scaling of the signal (0 V for 0 bar). The output load must be selected as highly resistive (with typical minimum value 4.7 kΩ). SUCO transmitters with voltage output have a 3-wire design.

The maximum connection length should not exceed 30 m to prevent significant voltage drops in the signal line.

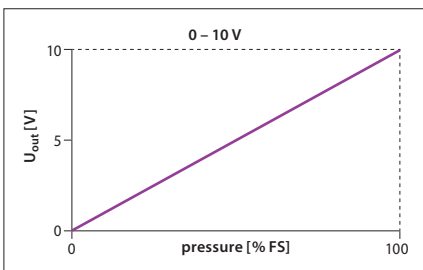

Conversion formula for pressure and voltage:

$$U_{\text{out}} = \frac{\text{pressure applied}}{\text{pressure range}} \times 10 \text{ V}$$

Voltage output

0.5 – 4.5 V ratiometric

SUCO transmitters with ratiometric output are operated with a 5 V supply voltage as 3-wire configuration.

The output signal is directly proportional/dependent to/on the supply voltage; this is known as a ratiometric dependency.

0.5 – 4.5 V is established as an output voltage because many A/D converters work with reference voltage U_{V+} of 5 V. The output voltage 0.5 V equals to 10% and 4.5 V corresponds to 90% of the supply voltage. The span is therefore 80% of the supply voltage.

This variant is used for example when a transmitter and a downstream A/D converter as an evaluation unit are to be powered with the same reference / operating voltage.

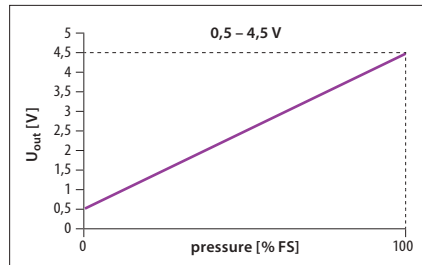

Conversion formula for pressure and voltage:

$$U_{\text{out}} = 0,1 \times U_{V+} + \frac{\text{pressure applied}}{\text{pressure range}} \times 0,8 \text{ V} \times U_{V+}$$

where U_{V+} = operating voltage

Current output 4 – 20 mA

The most common analogue output signal of sensors is 4 – 20 mA current output (as 2-wire configuration). The advantage of a 4 – 20 mA output signal is the 4 mA offset which allows the monitoring of potential wire break and short-circuit (life zero signal). The signal can also be transmitted over long distances with no loss in accuracy. This variant is also the least sensitive to EMC factors. 2-wire technology also means wiring overhead is reduced.

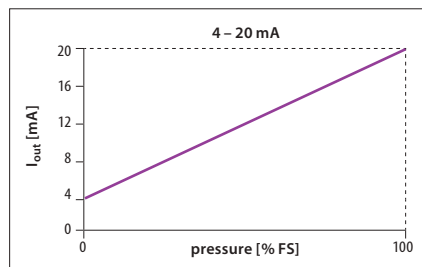

Conversion formula for pressure and current:

$$I_{\text{out}} = 4 \text{ mA} + \frac{\text{pressure applied}}{\text{pressure range}} \times 16 \text{ mA}$$

Output for vacuum transmitters

As depicted in the sketch below the output is at maximum signal at zero pressure.

Therefore at maximum vacuum the output signal is at its minimum.

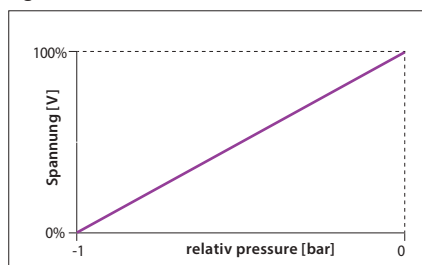

Load / apparent ohmic resistance for pressure transmitters

An appropriate ohmic load must be connected to guarantee perfect functioning of a pressure transmitter.

For transmitters with a voltage output (V), the load should be at least 4.7 kΩ.

For transmitters with a current output (4 - 20 mA), the maximum load is calculated using the following formula:

$$R_L = \frac{U_{V+} - U_{V+(min)}}{20 \text{ mA}}$$

$U_{V+(min)}$ is the minimum supply voltage - to be taken from the data sheet. $U_{V+(min)} = 10 \text{ V}$ gives the following operating range for example:

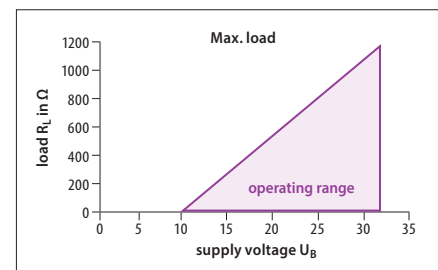

Supply / operating voltage U_B

All pressure transmitters work with DC voltage and have no galvanic isolation. Within the thresholds specified in the relevant data sheet, the supply voltage may change without influencing the output signal. (the ratiometric variant is an exception).

To guarantee the functionality of a transmitter, the minimum supply voltage may not fall below. The maximum operating voltage may not be exceeded to avoid damage on the electronics.

Technical explanations for pressure transmitters

Accuracy (to DIN EN 61298)

The (measuring) accuracy of pressure transmitters is specified by SUCO as $\pm 0.5\%$ or $\pm 1\%$ of the span (also called full scale). Accuracy includes zero point offset, non-linearity, hysteresis and non-repeatability, and is defined at room temperature and new state. This method defines the maximum deviation from the ideal line (in contrast to the BSFL method in which the average deviation is given). Other factors influencing the total accuracy, such as temperature and ageing, are specified separately.

Non-linearity (to DIN EN 61298)

Non-linearity (also linearity) defines the deviation of the actual output curve from the theoretical ideal line. SUCO specifies the maximum error in relation to the overall span or full scale (FS) of the pressure range.

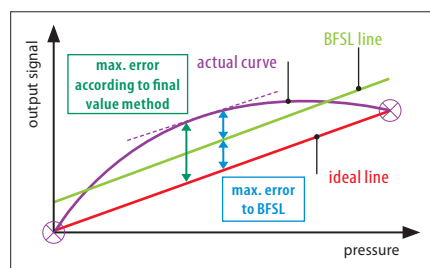

Non-linearity is also shown as BFSL (Best Fit Straight Line) as a reference value in the technical specifications. Non-linearity generally has the biggest influence on the overall error rate. Typically, non-linearity as per BFSL corresponds to half of non-linearity as per the full scale method ($1\% \text{ FS} \sim 0.5\% \text{ BFSL}$).

Hysteresis (to DIN EN 61298)

For a pressure transmitter, hysteresis specifies the difference of output signal between a rising and falling pressure, and is typically very low and negligible for SUCO pressure transmitters.

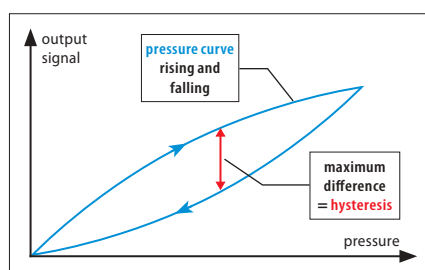

Non-repeatability (to DIN EN 61298)

Non-repeatability defines reproducibility of the output signal. The pressure is attained three times for example - the maximum variance between these three values gives the non-repeatability.

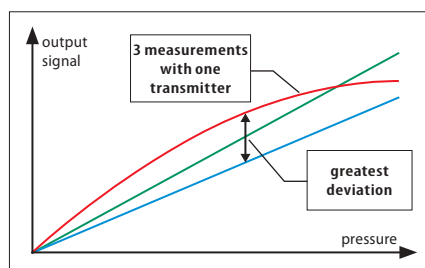

Temperature errors and ranges

The temperature (both of the medium and ambience) generally has a significant influence on the accuracy of a pressure transmitter. Pressure transmitters are temperature compensated over a particular range corresponding to the typical application. This means that temperature errors within this temperature range are minimised by means of circuitry design and algorithms. The temperature error is added to the accuracy, and shown in the total error band of the pressure transmitter, also called *butterfly graph*. Outside the compensated temperature range, the maximum error is not defined, however the pressure transmitter still functions.

To prevent mechanical and electrical damage, pressure transmitters may not be deployed beyond the threshold temperature ranges specified in the data sheet.

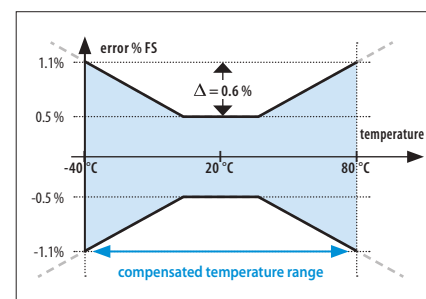

Service life and long-term stability

Service life information pertains to nominal conditions specified in the data sheet, and can vary considerably when a product is operated mechanically or electrically outside the specifications. Service life essentially depends on the used measuring cell technology.

Ageing is accelerated (or slowed) due to different factors - such as temperature, temperature change and reduction of mechanical forces. The occurrence of ageing does effect the total accuracy.

SUCO specifies long-term stability in accordance with DIN 16086 in relation to one year. Typically the influence of aging on the accuracy reduces with increasing operating duration. The information in the data sheet corresponds to the worst case scenario.

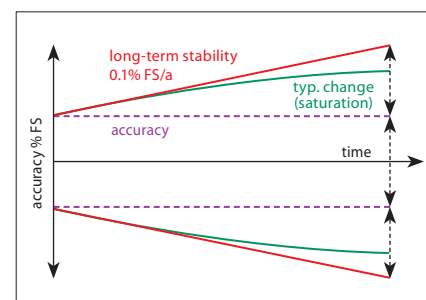

Resolution

The A/D resolution (analogue - digital) of an pressure transmitter defines the smallest change of the analogue – digital – analogue conversion which takes places by the signal processing of an pressure transmitter. If for example 13-bit resolution is used for an pressure transmitter with a 100 bar setting range, the smallest signal change is 8192 steps (2^{13}). As state of the art a resolution of 12 bits and hence 4096 steps (2^{12}) is typical. Therefore pressure changes of 100 bar / 4096 = 0.024 bar can be recorded.

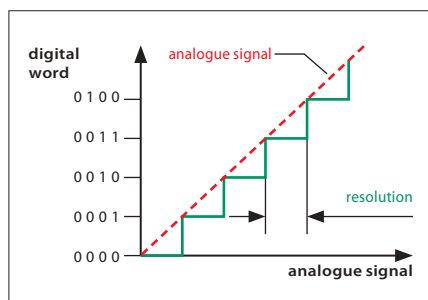

Sampling rate

The sampling rate (or sampling frequency) defines the number of samples per time unit (typically in seconds or milliseconds) taken from an analogue signal and converted to a digital signal. The sampling rate is an indicator of how fast the output signal of a pressure transmitter responds to the pressure change at the input.

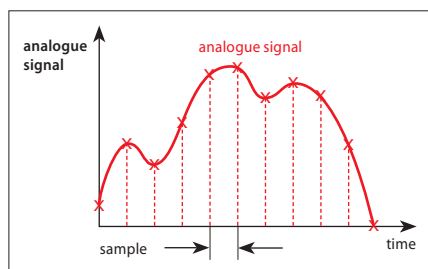

Response time

The response or circuit time is shorter than 2 to 4 milliseconds (depending on model). The sum of A/D and D/A conversions, and the analogue and digital filters in the signal chain from the measuring bridge to the output, make up the response time. Filtering is used to suppress unwanted pressure peaks and electrical interference signals, and for good EMC characteristics.

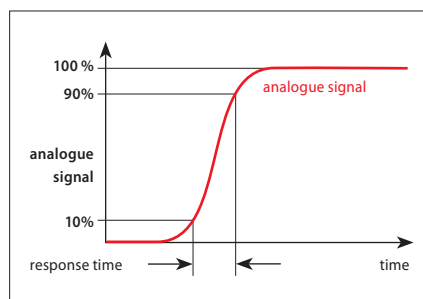

CE mark

Pressure transmitters from SUCO fall under the 2014/30/EU EMC Directive. EC declarations of conformity have been issued for the pressure transmitters and are available on request or can be downloaded from our website. The relevant devices are denoted by a CE mark in our catalogue.

The Machinery Directive 2006/42/EC is not applicable, because our products are classed as components.

Our products are designed for Group 2 fluids based upon good engineering practise in line with Pressure Equipment Directive 2014/68/EU, meaning neither a declaration of conformation may be issued nor a CE mark affixed.

Generic standard	Test standard	Parameter(s)
Radio disturbance and immunity	EN 55016-2-1 EN 55016-2-3	60 dBuV
Radiated, high-frequency electromagnetic field immunity test	EN 61000-4-3	10 V/m; 80-2700 MHz, 3 V/m; 1400-2000 MHz, 1 V/m; 2000-2700 MHz
Immunity to conducted disturbances, induced by radio-frequency fields	EN 61000-4-6	10 V; 0.15-80 MHz
Electrical fast transient / burst immunity test	EN 61000-4-4	±2 kV
Surge immunity test	EN 61000-4-5	±0.5 kV (common) ±0.5 kV (differential)
Electrostatic discharge (ESD) immunity test	EN 61000-4-2	air: 8 kV with contact: 4 kV

Electromagnetic compatibility (EMC)

Pressure transmitters from SUCO do comply to all important industrial EMC standards. The basis for the standards are the stricter thresholds for transient emissions in residential environments (EN 61000-6-3) and immunity for industrial environments (EN 61000-6-2).

Technical explanations for pressure transmitters

Conversion chart for pressure units

Abbreviation for unit	Name of unit	Pa= N/m ²	bar	Torr	lbf/in ² . PSI
1 Pa = N/m ²	Pascal	1	0.00001	0.0075	0.00014
1 bar	Bar	100 000	1	750.062	14.5
1 Torr = 1 mm Hg	Millimeters of mercury	133.322	0.00133	1	0.01934
1 lbf/in ² = 1 PSI	Pound-force per square inch	6894	0.06894	51.71	1

Conversion chart for temperature units

	K	°C	F
K	1	K-273.15	9/5 K-459.67
°C	°C + 273.15	1	9/5 °C + 32
F	5/9 (F+459.67)	5/9 (F-32)	1

Insulation strength

According to the latest specifications for immunity to surges and lightning protection, the following must be taken into account when testing insulation strength: With insulation test devices having an inner resistance exceeding 42 Ohm, the insulation strength of pressure transmitters can be tested up to 500 VDC. All contacts must be tested short-circuited against the housing. For a specific threshold value of test voltage, the protective circuit for surge protection is activated without any defects arising within the circuit. In the process, the current may rise to a point at which an insulation strength fault is indicated. The recommendation therefore is to conduct the insulation test of the pressure transmitter when it is removed, or independently of the overall system.

Medium compatibility

The specifications on medium compatibility in this catalogue pertain to the specific seal and housing materials as well as the used measuring cell technology and so cannot be generalised.

Titanium

Its high levels of mechanical resistance and the wide media compatibility – in particular to corrosive media – do make titanium the ideal material for measuring cells and membranes. It is not recommended for oxygen or hydrogen applications.

Stainless steel (1.4305 / AISI 303)

Stainless steel with broad level of media compatibility. Also suitable for oxygen and hydrogen applications.

Stainless steel (1.4404 / AISI 316L)

Stainless steel with broad level of media compatibility. Also suitable for chemical industry and sea water applications.

Oxygen and hydrogen

Country-specific safety requirements and application guidelines must be observed if the medium to be monitored is oxygen or hydrogen, such as DGUV accident prevention regulations (DGUV 500, Section 2.32 and BGI 617).

**Please specify when ordering
"for oxygen, oil and grease-free".**

Pressure peak dampening

If required, our pressure transmitters can also be fitted with a pressure snubber (pressure peak orifice) to protect the measuring cell against transient pressure loads such as pressure peaks due to the switching of valves, cavitation effects, etc. which can shorten life expectancy.

For liquid media, the hole of a pressure snubber cannot be chosen to be any small size. At low temperatures the viscosity of the media will increase. In a case of dropping pressure the media might remain in the cavity behind the snubber which might affect the functionality of the pressure transmitter. Thus a bore diameter of 0.8 mm has been established.

Product information

The technical information in this catalogue is based upon fundamental testing during product development, as well as upon empirical values. The information cannot be used for all application scenarios.

Testing of the suitability of our products for a specific application (e.g. also the checking of material compatibilities) falls under the responsibility of the user. It may be the case that suitability can only be guaranteed with appropriate field testing.

Subject to technical changes.

Order correctly – it's quite simple

Explanation of SUCO order numbers

P _{max.} in bar	Adjustment range in bar	Tolerance in bar at room temperature	Male thread	Order number
0170 Diaphragm pressure switches with spade terminal				
100 ¹⁾	0.3 – 1.5	± 0.2	G 1/4	0170 – 457 03 – X – 003
			M 10x1 con.	0170 – 457 01 – X – 001
			M 12x1.5 cyl.	0170 – 457 02 – X – 002
			NPT 1/8	0170 – 457 04 – X – 318
			NPT 1/4	0170 – 457 09 – X – 314
			7/16-20 UNF	0170 – 457 20 – X – 301
			9/16-18 UNF	0170 – 457 21 – X – 302

Order number: 0170 – 457 04 – X – 318

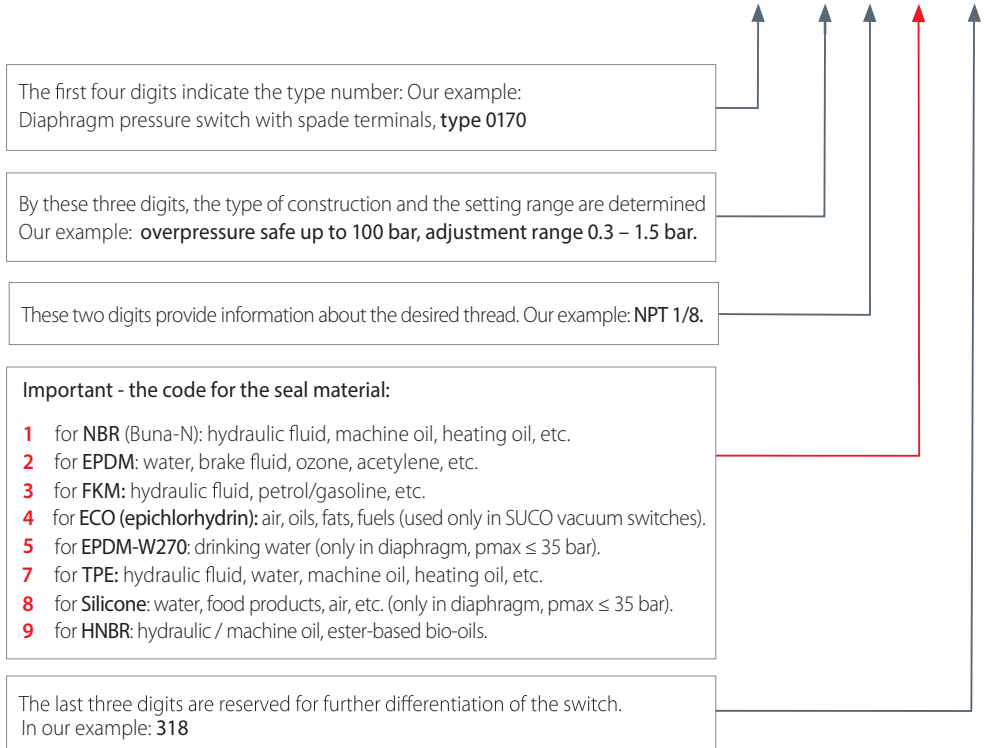

Abbreviated coding explanation is embossed on the hex surface areas of the pressure switches.

