

DC Disconnect Switches

Product Line D200





Safely into the future!

Visions about changes

Energy is one of the key topics that concern us on a daily basis. For maximum safety and availability, the requirements of electrical infrastructures need to be reviewed and the appropriate products supplied. In most cases the generation and use of renewable energy requires switching of DC Loads, and yet the last generation of these switches still bore the characteristics of the familiar AC switches. With the new D200, Sälzer is now in the position to supply a new kind of switch that has been developed from concept. Its main aim is to provide safe, low-loss and permanent switching of DC and it supports processes where the currently available switches for DC and AC have reached their limits.

Unlock a wide range of applications for yourself

- Wind turbines and photovoltaic systems
- Inverter systems for photovoltaic
- EV charging points/eMobility
- DC electric motors (as the main switch or maintenance switch)
- Rail sectors
- Battery chargers and recharging stations

D200 – making the best contacts

The D200 is an outstanding product mainly due to its new operating principle which guaranties pin point accuracy of the contact plates. The silver alloy self-cleaning contacts guarantee permanently low contact resistance with very little contact wear.

More product features

- Double-break per contact stage
- Very high level of long-term stability of switching parameters
- Operator-independent switching action
- Forced opening of contacts when switching on and off
- Compact design with standard overall height for all capacities
- Complies with IEC 60947-3 and VDE 0660
- Applicable for systems conforming to IEC 60364-7-712:2007

For safe use in the DC sector

Sälzer provides for controlled plasma reduction with the D200 by means of optimized arc deflection. The new system also contains an advanced arc reduction system for voltages of 800 V DC to 1000 V DC and achieves a high level of thermal stability with minimal current heat losses.





DC Disconnect Switches

Product Line D200

as of p. 6

Technical Information

as of p. 21

SMD – Sälzer Modular Design



Faster delivery by SMD!

The SMD (Sälzer Modular Design) is based on a modular product idea so that very high flexibility in product options is possible.

SMD modules are individually prefabricated and tested complete modules. By combining these basic elements, different switch configurations can be realised within short time spans. The switches required by you, the customer, are available for despatch following the assembly of the basic switch module to the mounting form and operator modules (SMD Service).

Within 24 hours, the solution matched to your requirements is ready for despatch – worldwide.

DC Disconnect Switches

Product overview

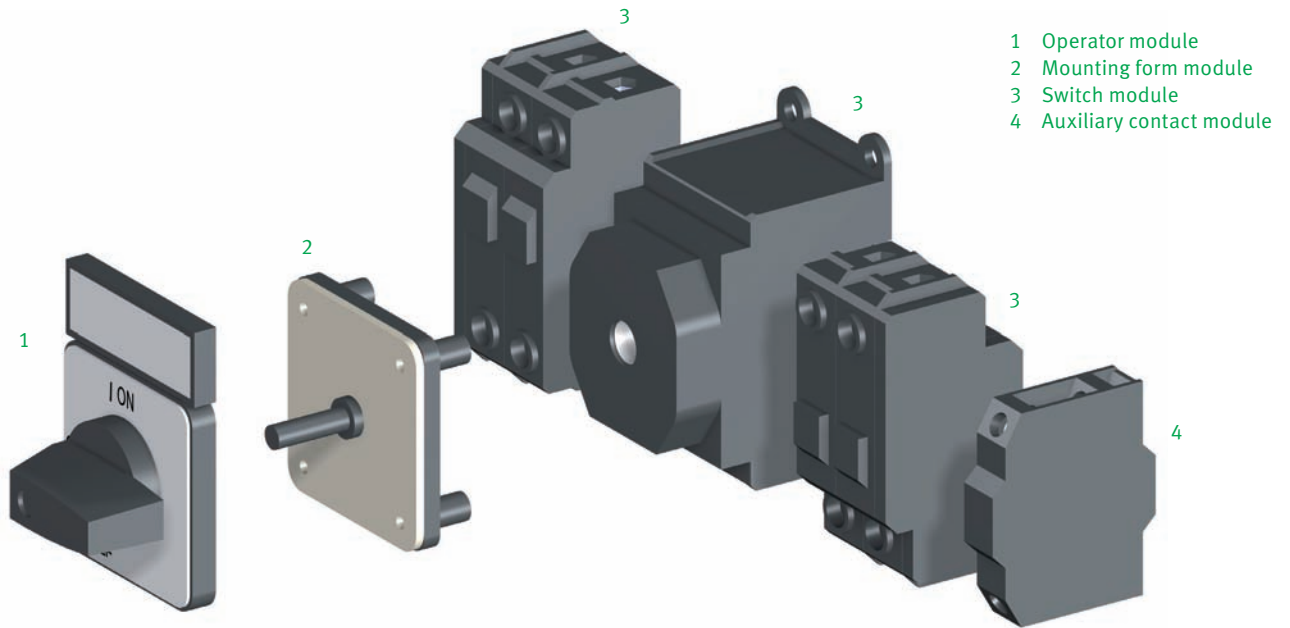

Mounting options:

Front Mounting

- Four hole mounting



Base Mounting

- Snap-on mounting



Enclosed Switches

- Insulated enclosure



With a broad range of mounting and operator options, Sälzer Electric can provide economical, versatile and reliable solutions!

All products are available
in different versions

Setup of order code number:

The 16 digit order code number for complete switches consists of the three ident numbers for type, switching programme and mounting form:



- the **type** specifies the physical size and power rating of the switch
- the **switching programme** specifies the switching arrangement
- the **mounting form** specifies the mounting, types of handle and optional extras.

In addition to the order code number, each complete switch is assigned a machine readable 13 digit EAN Code.

On the individual product pages you will find detailed all possible combinations for the Standard Switching Programmes, hence you will only require the order code number for the complete switch.

Additional switching programmes and auxiliary contact modules can be found from page 21 where the new order code number for the switching programme can be identified. Please note that the identification number of the switching programme must now be replaced by the new selection.

DC Disconnect Switches / Product Line D200

Front mounting Four hole mounting

Front mounting

- Front mounting switches with four hole mounting 36 × 36 mm
- 2 pole
- 250 V up to 1000 V DC
- 10 A up to 50 A
- IP66

- Main/Emergency-Off Switches
- Main Switches
- ON-OFF Switches



Switching programme	→ Main/Emergency-Off Switches											
	Rated data (IEC 60947)					Terminal capacities (mm ²)				Padlock device N-handle yellow/red	Padlock device M-handle yellow/red	Padlockable handle V-handle yellow/red
83200 1 string	Operational current DC21-B I _e at					solid		flexible				
	250 V	450 V	650 V	800 V	1000 V	min	max	min	max	Order code number	Order code number	Order code number
	20 A	16 A	10 A			1	10	0.75	6	D211-83200-033N4	D211-83200-033M4	D211-83200-033V4
		32 A	20 A			1	10	0.75	6	D221-83200-033N4	D221-83200-033M4	D221-83200-033V4
	50 A	40 A	32 A			4	16	2.5	10	D222-83200-033N4	D222-83200-033M4	D222-83200-033V4
				32 A	20 A	1	10	0.75	6	D241-83200-033N4	D241-83200-033M4	D241-83200-033V4
				50 A	20 A	4	16	2.5	10	D242-83200-033N4	D242-83200-033M4	D242-83200-033V4
→ Main Switches:												
	Rated data (IEC 60947)					Terminal capacities (mm ²)				Padlock device N-handle black	Padlock device M-handle black	Padlockable handle V-handle silver/black
	Operational current DC21-B I _e at					solid		flexible				
	250 V	450 V	650 V	800 V	1000 V	min	max	min	max	Order code number	Order code number	Order code number
	20 A	16 A	10 A			1	10	0.75	6	D211-83200-033N1	D211-83200-033M1	D211-83200-033V1
		32 A	20 A			1	10	0.75	6	D221-83200-033N1	D221-83200-033M1	D221-83200-033V1
	50 A	40 A	32 A			4	16	2.5	10	D222-83200-033N1	D222-83200-033M1	D222-83200-033V1
				32 A	20 A	1	10	0.75	6	D241-83200-033N1	D241-83200-033M1	D241-83200-033V1
				50 A	20 A	4	16	2.5	10	D242-83200-033N1	D242-83200-033M1	D242-83200-033V1
→ ON-OFF Switches												
	Rated data (IEC 60947)					Terminal capacities (mm ²)				M-handle silver/black		
	Operational current DC21-B I _e at					solid		flexible				
	250 V	450 V	650 V	800 V	1000 V	min	max	min	max	Order code number		
	20 A	16 A	10 A			1	10	0.75	6	D211-83200-003M1		
		32 A	20 A			1	10	0.75	6	D221-83200-003M1		
	50 A	40 A	32 A			4	16	2.5	10	D222-83200-003M1		
				32 A	20 A	1	10	0.75	6	D241-83200-003M1		
				50 A	20 A	4	16	2.5	10	D242-83200-003M1		

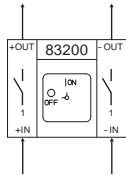

Switching programme	→ Main/Emergency-Off Switches											
	Rated data (IEC 60947)					Terminal capacities (mm ²)				Padlock device N-handle yellow/red	Padlock device M-handle yellow/red	Padlockable handle V-handle yellow/red
83300 1 string	Operational current DC21-B I _e at					solid		flexible				
	250 V	450 V	650 V	800 V	1000 V	min	max	min	max	Order code number	Order code number	Order code number
				32 A	32 A	1	10	0.75	6	D241-83300-033N4	D241-83300-033M4	D241-83300-033V4
				50 A	50 A	4	16	2.5	10	D242-83300-033N4	D242-83300-033M4	D242-83300-033V4
→ Main Switches:												
83300	Rated data (IEC 60947)					Terminal capacities (mm ²)				Padlock device N-handle black	Padlock device M-handle black	Padlockable handle V-handle silver/black
	Operational current DC21-B I _e at					solid		flexible				
250 V	450 V	650 V	800 V	1000 V	min	max	min	max	Order code number	Order code number	Order code number	
			32 A	32 A	1	10	0.75	6	D241-83300-033N1	D241-83300-033M1	D241-83300-033V1	
			50 A	50 A	4	16	2.5	10	D242-83300-033N1	D242-83300-033M1	D242-83300-033V1	
→ ON-OFF Switches												
83300	Rated data (IEC 60947)					Terminal capacities (mm ²)				M-handle silver/black		
	Operational current DC21-B I _e at					solid		flexible				
250 V	450 V	650 V	800 V	1000 V	min	max	min	max	Order code number			
			32 A	32 A	1	10	0.75	6	D241-83300-003M1			
			50 A	50 A	4	16	2.5	10	D242-83300-003M1			
84200 2 strings	→ Main/Emergency-Off Switches											
	Rated data (IEC 60947)					Terminal capacities (mm ²)				Padlock device N-handle yellow/red	Padlock device M-handle yellow/red	Padlockable handle V-handle yellow/red
84200	Operational current DC21-B I _e at					solid		flexible				
	250 V	450 V	650 V	800 V	1000 V	min	max	min	max	Order code number	Order code number	Order code number
	20 A	16 A	10 A			1	10	0.75	6	D211-84200-033N4	D211-84200-033M4	D211-84200-033V4
		32 A	20 A			1	10	0.75	6	D221-84200-033N4	D221-84200-033M4	D221-84200-033V4
	50 A	40 A	32 A			4	16	2.5	10	D222-84200-033N4	D222-84200-033M4	D222-84200-033V4
			32 A	20 A		1	10	0.75	6	D241-84200-033N4	D241-84200-033M4	D241-84200-033V4
			50 A	20 A		4	16	2.5	10	D242-84200-033N4	D242-84200-033M4	D242-84200-033V4
→ Main Switches:												
84200	Rated data (IEC 60947)					Terminal capacities (mm ²)				Padlock device N-handle black	Padlock device M-handle black	Padlockable handle V-handle silver/black
	Operational current DC21-B I _e at					solid		flexible				
250 V	450 V	650 V	800 V	1000 V	min	max	min	max	Order code number	Order code number	Order code number	
	20 A	16 A	10 A			1	10	0.75	6	D211-84200-033N1	D211-84200-033M1	D211-84200-033V1
		32 A	20 A			1	10	0.75	6	D221-84200-033N1	D221-84200-033M1	D221-84200-033V1
	50 A	40 A	32 A			4	16	2.5	10	D222-84200-033N1	D222-84200-033M1	D222-84200-033V1
			32 A	20 A		1	10	0.75	6	D241-84200-033N1	D241-84200-033M1	D241-84200-033V1
			50 A	20 A		4	16	2.5	10	D242-84200-033N1	D242-84200-033M1	D242-84200-033V1
→ ON-OFF Switches												
84200	Rated data (IEC 60947)					Terminal capacities (mm ²)				M-handle silver/black		
	Operational current DC21-B I _e at					solid		flexible				
250 V	450 V	650 V	800 V	1000 V	min	max	min	max	Order code number			
	20 A	16 A	10 A			1	10	0.75	6	D211-84200-003M1		
		32 A	20 A			1	10	0.75	6	D221-84200-003M1		
	50 A	40 A	32 A			4	16	2.5	10	D222-84200-003M1		
			32 A	20 A		1	10	0.75	6	D241-84200-003M1		
			50 A	20 A		4	16	2.5	10	D242-84200-003M1		

DC Disconnect Switches / Product Line D200

Front mounting Four hole mounting

Switching programme	→ Main/Emergency-Off Switches											
	Rated data (IEC 60947)					Terminal capacities (mm ²)				Padlock device N-handle yellow/red	Padlock device M-handle yellow/red	Padlockable handle V-handle yellow/red
85200 3 strings	Operational current DC21-B I _e at					solid		flexible				
	250 V	450 V	650 V	800 V	1000 V	min	max	min	max	Order code number	Order code number	Order code number
	20 A	16 A	10 A			1	10	0.75	6	D211-85200-033N4	D211-85200-033M4	D211-85200-033V4
		32 A	20 A			1	10	0.75	6	D221-85200-033N4	D221-85200-033M4	D221-85200-033V4
	50 A	40 A	32 A			4	16	2.5	10	D222-85200-033N4	D222-85200-033M4	D222-85200-033V4
			32 A	20 A	1	10	0.75	6	D241-85200-033N4	D241-85200-033M4	D241-85200-033V4	
			50 A	20 A	4	16	2.5	10	D242-85200-033N4	D242-85200-033M4	D242-85200-033V4	

Switching programme	→ Main Switches:											
	Rated data (IEC 60947)					Terminal capacities (mm ²)				Padlock device N-handle black	Padlock device M-handle black	Padlockable handle V-handle silver/black
85200 3 strings	Operational current DC21-B I _e at					solid		flexible				
	250 V	450 V	650 V	800 V	1000 V	min	max	min	max	Order code number	Order code number	Order code number
	20 A	16 A	10 A			1	10	0.75	6	D211-85200-033N1	D211-85200-033M1	D211-85200-033V1
		32 A	20 A			1	10	0.75	6	D221-85200-033N1	D221-85200-033M1	D221-85200-033V1
	50 A	40 A	32 A			4	16	2.5	10	D222-85200-033N1	D222-85200-033M1	D222-85200-033V1
			32 A	20 A	1	10	0.75	6	D241-85200-033N1	D241-85200-033M1	D241-85200-033V1	
			50 A	20 A	4	16	2.5	10	D242-85200-033N1	D242-85200-033M1	D242-85200-033V1	

Switching programme	→ ON-OFF Switches									
	Rated data (IEC 60947)					Terminal capacities (mm ²)				M-handle silver/black
85200 3 strings	Operational current DC21-B I _e at					solid		flexible		
	250 V	450 V	650 V	800 V	1000 V	min	max	min	max	Order code number
	20 A	16 A	10 A			1	10	0.75	6	D211-85200-003M1
		32 A	20 A			1	10	0.75	6	D221-85200-003M1
	50 A	40 A	32 A			4	16	2.5	10	D222-85200-003M1
			32 A	20 A	1	10	0.75	6	D241-85200-003M1	
			50 A	20 A	4	16	2.5	10	D242-85200-003M1	

Further switching programmes from page 21.

Dimensions (mm):

Setup of order code number

Type	Switching progr.	Mtg. form
D211	85200	003M1

Order code no. **D211-85200-003M1**

Mounting form	Switching progr.	A	B	C	C1	D1	D2	E	H
003M1 / 033V1 / 033V4	83200	48	77	61	32	12	4.5	36	80
003M1 / 033V1 / 033V4	83300	48	92	61	32	12	4.5	36	80
003M1 / 033V1 / 033V4	84200	48	106	61	32	12	4.5	36	80
003M1 / 033V1 / 033V4	85200	48	135	61	32	12	4.5	36	80
033M1 / 033M4	83200	67	77	61	38	12	4.5	36	80
033M1 / 033M4	83300	67	92	61	38	12	4.5	36	80
033M1 / 033M4	84200	67	106	61	38	12	4.5	36	80
033M1 / 033M4	85200	67	135	61	38	12	4.5	36	80
033N1 / 033N4	83200	67	77	61	33	12	4.5	36	80
033N1 / 033N4	83300	67	92	61	33	12	4.5	36	80
033N1 / 033N4	84200	67	106	61	33	12	4.5	36	80
033N1 / 033N4	85200	67	135	61	33	12	4.5	36	80

Base mounting

- Base mounting switches with snap-on mounting
- for DIN rail
- 2 pole
- 250 V up to 1000 V DC
- 10 A up to 50 A
- IP30

- Main/Emergency-Off Switches
- Main Switches
- ON-OFF Switches



Switching programme	Rated data (IEC 60947)				Terminal capacities (mm ²)				→ Main/Emergency-Off Sw.	→ Main Switches:	→ ON-OFF Switches	
	Operational current DC21-B I _g at				solid		flexible		Padlockable handle V-handle yellow/red	Padlockable handle V-handle silver/black	M-handle silver/black	
	250 V	450 V	650 V	800 V	1000 V	min	max	min	max	Order code number	Order code number	Order code number
83200 1 string 	20 A	16 A	10 A			1	10	0.75	6	D211-83200-026V4	D211-83200-026V1	D211-83200-026M1
		32 A	20 A			1	10	0.75	6	D221-83200-026V4	D221-83200-026V1	D221-83200-026M1
	50 A	40 A	32 A			4	16	2.5	10	D222-83200-026V4	D222-83200-026V1	D222-83200-026M1
				32 A	20 A	1	10	0.75	6	D241-83200-026V4	D241-83200-026V1	D241-83200-026M1
				50 A	20 A	4	16	2.5	10	D242-83200-026V4	D242-83200-026V1	D242-83200-026M1
83300 1 string 				32 A	32 A	1	10	0.75	6	D241-83300-026V4	D241-83300-026V1	D241-83300-026M1
				50 A	50 A	4	16	2.5	10	D242-83300-026V4	D242-83300-026V1	D242-83300-026M1
84200 2 strings 	20 A	16 A	10 A			1	10	0.75	6	D211-84200-026V4	D211-84200-026V1	D211-84200-026M1
		32 A	20 A			1	10	0.75	6	D221-84200-026V4	D221-84200-026V1	D221-84200-026M1
	50 A	40 A	32 A			4	16	2.5	10	D222-84200-026V4	D222-84200-026V1	D222-84200-026M1
				32 A	20 A	1	10	0.75	6	D241-84200-026V4	D241-84200-026V1	D241-84200-026M1
				50 A	20 A	4	16	2.5	10	D242-84200-026V4	D242-84200-026V1	D242-84200-026M1
85200 3 strings 	20 A	16 A	10 A			1	10	0.75	6	D211-85200-026V4	D211-85200-026V1	D211-85200-026M1
		32 A	20 A			1	10	0.75	6	D221-85200-026V4	D221-85200-026V1	D221-85200-026M1
	50 A	40 A	32 A			4	16	2.5	10	D222-85200-026V4	D222-85200-026V1	D222-85200-026M1
				32 A	20 A	1	10	0.75	6	D241-85200-026V4	D241-85200-026V1	D241-85200-026M1
				50 A	20 A	4	16	2.5	10	D242-85200-026V4	D242-85200-026V1	D242-85200-026M1

Further switching programmes from page 21.

Dimensions (mm):

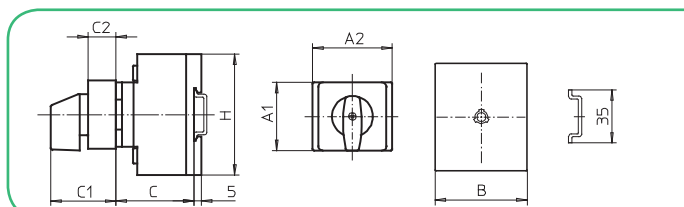

Switching progr.	A 1	A 2	B	C	C 1	C 2	H
83200	45	48	77	42	42	15.5	80
83300	45	48	92	42	42	15.5	80
84200	45	48	106	42	42	15.5	80
85200	45	48	135	42	42	15.5	80

DC Disconnect Switches / Product Line D200

Base mounting Snap-on mounting with door clutch

Base mounting

- Base mounting switches with snap-on mounting
- Door clutch with modular shaft extension
- Four hole front mounting 36 × 36 mm
- 2 pole
- 250 V up to 1000 V DC
- 10 A up to 50 A
- IP66 front

- Main/Emergency-Off Switches
- Main Switches
- ON-OFF Switches



i Switches with modular shaft extensions can be extended with additional modules which can be fitted to achieve different required mounting depths. The modules are detailed on p. 22.



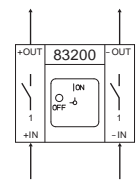



Switching programme	→ Main/Emergency-Off Switches											
	Rated data (IEC 60947)					Terminal capacities (mm ²)				Padlock device N-handle yellow/red	Padlock device M-handle yellow/red	Padlockable handle V-handle yellow/red
83200 1 string	Operational current DC21-B I _e at					solid		flexible				
	250 V	450 V	650 V	800 V	1000 V	min	max	min	max	Order code number	Order code number	Order code number
	20 A	16 A	10 A			1	10	0.75	6	D211-83200-232N4	D211-83200-232M4	D211-83200-232V4
		32 A	20 A			1	10	0.75	6	D221-83200-232N4	D221-83200-232M4	D221-83200-232V4
	50 A	40 A	32 A			4	16	2.5	10	D222-83200-232N4	D222-83200-232M4	D222-83200-232V4
			32 A	20 A		1	10	0.75	6	D241-83200-232N4	D241-83200-232M4	D241-83200-232V4
			50 A	20 A		4	16	2.5	10	D242-83200-232N4	D242-83200-232M4	D242-83200-232V4
→ Main Switches:												
	Rated data (IEC 60947)					Terminal capacities (mm ²)				Padlock device N-handle black	Padlock device M-handle black	Padlockable handle V-handle silver/black
	Operational current DC21-B I _e at					solid		flexible				
	250 V	450 V	650 V	800 V	1000 V	min	max	min	max	Order code number	Order code number	Order code number
	20 A	16 A	10 A			1	10	0.75	6	D211-83200-232N1	D211-83200-232M1	D211-83200-232V1
		32 A	20 A			1	10	0.75	6	D221-83200-232N1	D221-83200-232M1	D221-83200-232V1
	50 A	40 A	32 A			4	16	2.5	10	D222-83200-232N1	D222-83200-232M1	D222-83200-232V1
			32 A	20 A		1	10	0.75	6	D241-83200-232N1	D241-83200-232M1	D241-83200-232V1
			50 A	20 A		4	16	2.5	10	D242-83200-232N1	D242-83200-232M1	D242-83200-232V1
→ ON-OFF Switches												
	Rated data (IEC 60947)					Terminal capacities (mm ²)				M-handle silver/black		
	Operational current DC21-B I _e at					solid		flexible				
	250 V	450 V	650 V	800 V	1000 V	min	max	min	max	Order code number		
	20 A	16 A	10 A			1	10	0.75	6	D211-83200-241M1		
		32 A	20 A			1	10	0.75	6	D221-83200-241M1		
	50 A	40 A	32 A			4	16	2.5	10	D222-83200-241M1		
			32 A	20 A		1	10	0.75	6	D241-83200-241M1		
			50 A	20 A		4	16	2.5	10	D242-83200-241M1		

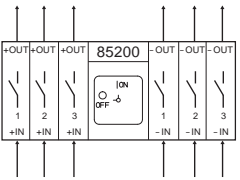

Switching programme	→ Main/Emergency-Off Switches											
	Rated data (IEC 60947)					Terminal capacities (mm ²)				Padlock device N-handle yellow/red	Padlock device M-handle yellow/red	Padlockable handle V-handle yellow/red
83300 1 string	Operational current DC21-B I _e at					solid		flexible				
	250 V	450 V	650 V	800 V	1000 V	min	max	min	max			
				32 A	32 A	1	10	0.75	6	D241-83300-232N4	D241-83300-232M4	D241-83300-232V4
				50 A	50 A	4	16	2.5	10	D242-83300-232N4	D242-83300-232M4	D242-83300-232V4
→ Main Switches:												
83300	Rated data (IEC 60947)					Terminal capacities (mm ²)				Padlock device N-handle black	Padlock device M-handle black	Padlockable handle V-handle silver/black
	Operational current DC21-B I _e at					solid		flexible				
250 V	450 V	650 V	800 V	1000 V	min	max	min	max	Order code number			
				32 A	32 A	1	10	0.75	6	D241-83300-232N1	D241-83300-232M1	D241-83300-232V1
				50 A	50 A	4	16	2.5	10	D242-83300-232N1	D242-83300-232M1	D242-83300-232V1
→ ON-OFF Switches												
83300	Rated data (IEC 60947)					Terminal capacities (mm ²)				M-handle silver/black		
	Operational current DC21-B I _e at					solid		flexible				
250 V	450 V	650 V	800 V	1000 V	min	max	min	max	Order code number			
				32 A	32 A	1	10	0.75	6	D241-83300-241M1		
				50 A	50 A	4	16	2.5	10	D242-83300-241M1		
84200 2 strings	→ Main/Emergency-Off Switches											
	Rated data (IEC 60947)					Terminal capacities (mm ²)				Padlock device N-handle yellow/red	Padlock device M-handle yellow/red	Padlockable handle V-handle yellow/red
84200	Operational current DC21-B I _e at					solid		flexible				
	250 V	450 V	650 V	800 V	1000 V	min	max	min	max			
	20 A	16 A	10 A			1	10	0.75	6	D211-84200-232N4	D211-84200-232M4	D211-84200-232V4
		32 A	20 A			1	10	0.75	6	D221-84200-232N4	D221-84200-232M4	D221-84200-232V4
	50 A	40 A	32 A			4	16	2.5	10	D222-84200-232N4	D222-84200-232M4	D222-84200-232V4
				32 A	20 A	1	10	0.75	6	D241-84200-232N4	D241-84200-232M4	D241-84200-232V4
				50 A	20 A	4	16	2.5	10	D242-84200-232N4	D242-84200-232M4	D242-84200-232V4
→ Main Switches:												
84200	Rated data (IEC 60947)					Terminal capacities (mm ²)				Padlock device N-handle black	Padlock device M-handle black	Padlockable handle V-handle silver/black
	Operational current DC21-B I _e at					solid		flexible				
250 V	450 V	650 V	800 V	1000 V	min	max	min	max	Order code number			
	20 A	16 A	10 A			1	10	0.75	6	D211-84200-232N1	D211-84200-232M1	D211-84200-232V1
		32 A	20 A			1	10	0.75	6	D221-84200-232N1	D221-84200-232M1	D221-84200-232V1
	50 A	40 A	32 A			4	16	2.5	10	D222-84200-232N1	D222-84200-232M1	D222-84200-232V1
				32 A	20 A	1	10	0.75	6	D241-84200-232N1	D241-84200-232M1	D241-84200-232V1
				50 A	20 A	4	16	2.5	10	D242-84200-232N1	D242-84200-232M1	D242-84200-232V1
→ ON-OFF Switches												
84200	Rated data (IEC 60947)					Terminal capacities (mm ²)				M-handle silver/black		
	Operational current DC21-B I _e at					solid		flexible				
250 V	450 V	650 V	800 V	1000 V	min	max	min	max	Order code number			
	20 A	16 A	10 A			1	10	0.75	6	D211-84200-241M1		
		32 A	20 A			1	10	0.75	6	D221-84200-241M1		
	50 A	40 A	32 A			4	16	2.5	10	D222-84200-241M1		
				32 A	20 A	1	10	0.75	6	D241-84200-241M1		
				50 A	20 A	4	16	2.5	10	D242-84200-241M1		

DC Disconnect Switches / Product Line D200

Base mounting Snap-on mounting with door clutch

Switching programme	→ Main/Emergency-Off Switches											
	Rated data (IEC 60947)					Terminal capacities (mm ²)				Padlock device N-handle yellow/red	Padlock device M-handle yellow/red	Padlockable handle V-handle yellow/red
85200 3 strings	Operational current DC21-B I _e at					solid		flexible		 Order code number	 Order code number	 Order code number
	250 V	450 V	650 V	800 V	1000 V	min	max	min	max			
	20 A	16 A	10 A			1	10	0.75	6	D211-85200-232N4	D211-85200-232M4	D211-85200-232V4
		32 A	20 A			1	10	0.75	6	D221-85200-232N4	D221-85200-232M4	D221-85200-232V4
	50 A	40 A	32 A			4	16	2.5	10	D222-85200-232N4	D222-85200-232M4	D222-85200-232V4
				32 A	20 A	1	10	0.75	6	D241-85200-232N4	D241-85200-232M4	D241-85200-232V4
				50 A	20 A	4	16	2.5	10	D242-85200-232N4	D242-85200-232M4	D242-85200-232V4
→ Main Switches:												
	Rated data (IEC 60947)					Terminal capacities (mm ²)				Padlock device N-handle black	Padlock device M-handle black	Padlockable handle V-handle silver/black
	Operational current DC21-B I _e at					solid		flexible		 Order code number	 Order code number	 Order code number
250 V	450 V	650 V	800 V	1000 V	min	max	min	max				
	20 A	16 A	10 A			1	10	0.75	6	D211-85200-232N1	D211-85200-232M1	D211-85200-232V1
		32 A	20 A			1	10	0.75	6	D221-85200-232N1	D221-85200-232M1	D221-85200-232V1
	50 A	40 A	32 A			4	16	2.5	10	D222-85200-232N1	D222-85200-232M1	D222-85200-232V1
				32 A	20 A	1	10	0.75	6	D241-85200-232N1	D241-85200-232M1	D241-85200-232V1
				50 A	20 A	4	16	2.5	10	D242-85200-232N1	D242-85200-232M1	D242-85200-232V1
→ ON-OFF Switches												
	Rated data (IEC 60947)					Terminal capacities (mm ²)				M-handle silver/black		
	Operational current DC21-B I _e at					solid		flexible		 Order code number		
250 V	450 V	650 V	800 V	1000 V	min	max	min	max				
	20 A	16 A	10 A			1	10	0.75	6	D211-85200-241M1		
		32 A	20 A			1	10	0.75	6	D221-85200-241M1		
	50 A	40 A	32 A			4	16	2.5	10	D222-85200-241M1		
				32 A	20 A	1	10	0.75	6	D241-85200-241M1		
				50 A	20 A	4	16	2.5	10	D242-85200-241M1		

Further switching programmes from page 21.

Dimensions (mm):

Setup of order code number

Type	Switching progr.	Mtg. form
D211	85200	241M1

Order code no. **D211-85200-241M1**

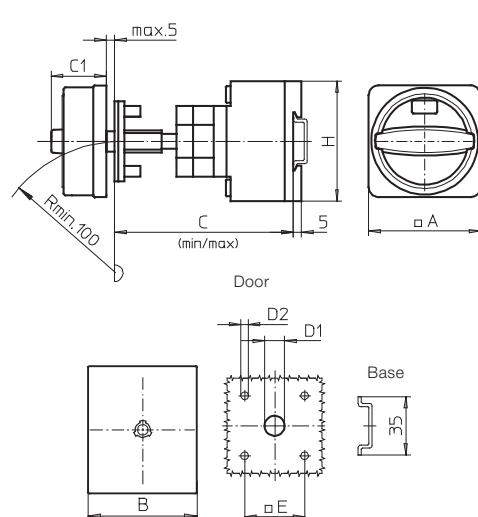

Mounting form	Switching progr.	A	B	C _{min}	C _{max}	C1	D1	D2	E	H
241M1 / 232V1 / 232V4	83200	48	77	92	109	32	12	4.5	36	80
241M1 / 232V1 / 232V4	83300	48	92	92	109	32	12	4.5	36	80
241M1 / 232V1 / 232V4	84200	48	106	92	109	32	12	4.5	36	80
241M1 / 232V1 / 232V4	85200	48	135	92	109	32	12	4.5	36	80
232M1 / 232M4	83200	67	77	92	109	38	15	4.5	36	80
232M1 / 232M4	83300	67	92	92	109	38	15	4.5	36	80
232M1 / 232M4	84200	67	106	92	109	38	15	4.5	36	80
232M1 / 232M4	85200	67	135	92	109	38	15	4.5	36	80
232N1 / 232N4	83200	67	77	92	109	33	15	4.5	36	80
232N1 / 232N4	83300	67	92	92	109	33	15	4.5	36	80
232N1 / 232N4	84200	67	106	92	109	33	15	4.5	36	80
232N1 / 232N4	85200	67	135	92	109	33	15	4.5	36	80

Enclosed Switches

- Insulated enclosure (polycarbonate)
- 125 × 100 × 85 mm (H × W × D)
- Cover interlock in ON position
- 2 pole
- 250 V up to 1000 V DC
- 10 A up to 50 A
- IP66

- Main/Emergency-Off Switches
- Main Switches
- ON-OFF Switches



Switching programme	→ Main/Emergency-Off Switches											
	Rated data (IEC 60947)					Terminal capacities (mm ²)				Padlock device N-handle yellow/red	Padlock device M-handle yellow/red	Padlockable handle V-handle yellow/red
83200 1 string	Operational current DC21-B I _e at					solid		flexible				
	250 V	450 V	650 V	800 V	1000 V	min	max	min	max	Order code number	Order code number	Order code number
	20 A	16 A	10 A			1	10	0.75	6	D211-83200-700N4	D211-83200-700M4	D211-83200-700V4
		32 A	20 A			1	10	0.75	6	D221-83200-700N4	D221-83200-700M4	D221-83200-700V4
	50 A	40 A	32 A			4	16	2.5	10	D222-83200-700N4	D222-83200-700M4	D222-83200-700V4
				32 A	20 A	1	10	0.75	6	D241-83200-700N4	D241-83200-700M4	D241-83200-700V4
				50 A	20 A	4	16	2.5	10	D242-83200-700N4	D242-83200-700M4	D242-83200-700V4
→ Main Switches:												
	Rated data (IEC 60947)					Terminal capacities (mm ²)				Padlock device N-handle black	Padlock device M-handle black	Padlockable handle V-handle silver/black
	Operational current DC21-B I _e at					solid		flexible				
	250 V	450 V	650 V	800 V	1000 V	min	max	min	max	Order code number	Order code number	Order code number
	20 A	16 A	10 A			1	10	0.75	6	D211-83200-700N1	D211-83200-700M1	D211-83200-700V1
		32 A	20 A			1	10	0.75	6	D221-83200-700N1	D221-83200-700M1	D221-83200-700V1
	50 A	40 A	32 A			4	16	2.5	10	D222-83200-700N1	D222-83200-700M1	D222-83200-700V1
				32 A	20 A	1	10	0.75	6	D241-83200-700N1	D241-83200-700M1	D241-83200-700V1
				50 A	20 A	4	16	2.5	10	D242-83200-700N1	D242-83200-700M1	D242-83200-700V1
→ ON-OFF Switches												
	Rated data (IEC 60947)					Terminal capacities (mm ²)				M-handle silver/black		
	Operational current DC21-B I _e at					solid		flexible				
	250 V	450 V	650 V	800 V	1000 V	min	max	min	max	Order code number		
	20 A	16 A	10 A			1	10	0.75	6	D211-83200-701M1		
		32 A	20 A			1	10	0.75	6	D221-83200-701M1		
	50 A	40 A	32 A			4	16	2.5	10	D222-83200-701M1		
				32 A	20 A	1	10	0.75	6	D241-83200-701M1		
				50 A	20 A	4	16	2.5	10	D242-83200-701M1		

Further switching programmes from page 21.

Dimensions (mm):

Mounting form	H1	B1	T1	T2	2×M	H2
700M1 / 700M4	125	100	85	38	20/25	115
700N1 / 700N4	125	100	85	33	20/25	115
700V1 / 700V4 / 701M1	125	100	85	32	20/25	115

DC Disconnect Switches / Product Line D200

Enclosed Switches with insulated enclosure 175 × 115 × 100 mm

Enclosed Switches

- Insulated enclosure (polycarbonate)
- 175 × 115 × 100 mm (H × W × D)
- Cover interlock in ON position
- 2 pole
- 250 V up to 1000 V DC
- 10 A up to 50 A
- IP66

- Main/Emergency-Off Switches
- Main Switches
- ON-OFF Switches



Switching programme	→ Main/Emergency-Off Switches											
	Rated data (IEC 60947)					Terminal capacities (mm ²)				Padlock device N-handle yellow/red	Padlock device M-handle yellow/red	Padlockable handle V-handle yellow/red
83200 1 string	Operational current DC21-B I _e at					solid		flexible				
	250 V	450 V	650 V	800 V	1000 V	min	max	min	max	Order code number	Order code number	Order code number
	20 A	16 A	10 A			1	10	0.75	6	D211-83200-710N4	D211-83200-710M4	D211-83200-710V4
		32 A	20 A			1	10	0.75	6	D221-83200-710N4	D221-83200-710M4	D221-83200-710V4
	50 A	40 A	32 A			4	16	2.5	10	D222-83200-710N4	D222-83200-710M4	D222-83200-710V4
				32 A	20 A	1	10	0.75	6	D241-83200-710N4	D241-83200-710M4	D241-83200-710V4
				50 A	20 A	4	16	2.5	10	D242-83200-710N4	D242-83200-710M4	D242-83200-710V4
→ Main Switches:												
	Rated data (IEC 60947)					Terminal capacities (mm ²)				Padlock device N-handle black	Padlock device M-handle black	Padlockable handle V-handle silver/black
	Operational current DC21-B I _e at					solid		flexible				
	250 V	450 V	650 V	800 V	1000 V	min	max	min	max	Order code number	Order code number	Order code number
	20 A	16 A	10 A			1	10	0.75	6	D211-83200-710N1	D211-83200-710M1	D211-83200-710V1
		32 A	20 A			1	10	0.75	6	D221-83200-710N1	D221-83200-710M1	D221-83200-710V1
	50 A	40 A	32 A			4	16	2.5	10	D222-83200-710N1	D222-83200-710M1	D222-83200-710V1
				32 A	20 A	1	10	0.75	6	D241-83200-710N1	D241-83200-710M1	D241-83200-710V1
				50 A	20 A	4	16	2.5	10	D242-83200-710N1	D242-83200-710M1	D242-83200-710V1
→ ON-OFF Switches												
	Rated data (IEC 60947)					Terminal capacities (mm ²)				M-handle silver/black		
	Operational current DC21-B I _e at					solid		flexible				
	250 V	450 V	650 V	800 V	1000 V	min	max	min	max	Order code number		
	20 A	16 A	10 A			1	10	0.75	6	D211-83200-711M1		
		32 A	20 A			1	10	0.75	6	D221-83200-711M1		
	50 A	40 A	32 A			4	16	2.5	10	D222-83200-711M1		
				32 A	20 A	1	10	0.75	6	D241-83200-711M1		
				50 A	20 A	4	16	2.5	10	D242-83200-711M1		

Switching programme	→ Main/Emergency-Off Switches											
	89300 1 string 	Rated data (IEC 60947)					Terminal capacities (mm ²)				Padlock device N-handle yellow/red	Padlock device M-handle yellow/red
Operational current DC21-B I _e at					solid		flexible					
250 V		450 V	650 V	800 V	1000 V	min	max	min	max	Order code number	Order code number	Order code number
				32 A	32 A	1	10	0.75	6	D241-89300-710N4	D241-89300-710M4	D241-89300-710V4
			50 A	50 A	4	16	2.5	10	D242-89300-710N4	D242-89300-710M4	D242-89300-710V4	
→ Main Switches:												
	Rated data (IEC 60947)					Terminal capacities (mm ²)				Padlock device N-handle black	Padlock device M-handle black	Padlockable handle V-handle silver/black
	Operational current DC21-B I _e at					solid		flexible				
	250 V	450 V	650 V	800 V	1000 V	min	max	min	max	Order code number	Order code number	Order code number
				32 A	32 A	1	10	0.75	6	D241-89300-710N1	D241-89300-710M1	D241-89300-710V1
			50 A	50 A	4	16	2.5	10	D242-89300-710N1	D242-89300-710M1	D242-89300-710V1	
→ ON-OFF Switches												
	Rated data (IEC 60947)					Terminal capacities (mm ²)				M-handle silver/black		
	Operational current DC21-B I _e at					solid		flexible				
	250 V	450 V	650 V	800 V	1000 V	min	max	min	max	Order code number		
				32 A	32 A	1	10	0.75	6	D241-89300-711M1		
			50 A	50 A	4	16	2.5	10	D242-89300-711M1			

Further switching programmes from page 21.

Dimensions (mm):

Setup of order code number		
Type	Switching progr.	Mtg. form
D211	89300	710V1
Order code no. D211-89300-710V1		

Mounting form	H1	B1	T1	T2	2×M	H2
710M1 / 710M4	175	115	100	38	20/25	165
710N1 / 710N4	175	115	100	33	20/25	165
710V1 / 710V4 / 711M1	175	115	100	39	20/25	165

DC Disconnect Switches / Product Line D200

Enclosed Switches with insulated enclosure 250 × 160 × 120 mm

Enclosed Switches

- Insulated enclosure (polycarbonate)
- 250 × 160 × 120 mm (H × W × D)
- Cover interlock in ON position
- 2 pole
- 250 V up to 1000 V DC
- 10 A up to 50 A
- IP66

- Main/Emergency-Off Switches
- Main Switches
- ON-OFF Switches



Switching programme	→ Main/Emergency-Off Switches														
	Rated data (IEC 60947)					Terminal capacities (mm ²)				Padlock device N-handle yellow/red		Padlock device M-handle yellow/red		Padlockable handle V-handle yellow/red	
	Operational current DC21-B I _e at					solid		flexible							
	250 V	450 V	650 V	800 V	1000 V	min	max	min	max	Order code number		Order code number		Order code number	
84200 2 strings 	without PE connection link:														
	20 A	16 A	10 A			1	10	0.75	6	D211-84200-760N4	D211-84200-760M4	D211-84200-760V4			
		32 A	20 A			1	10	0.75	6	D221-84200-760N4	D221-84200-760M4	D221-84200-760V4			
	50 A	40 A	32 A			4	16	2.5	10	D222-84200-760N4	D222-84200-760M4	D222-84200-760V4			
				32 A	20 A	1	10	0.75	6	D241-84200-760N4	D241-84200-760M4	D241-84200-760V4			
				50 A	20 A	4	16	2.5	10	D242-84200-760N4	D242-84200-760M4	D242-84200-760V4			
	with PE connection link:														
	20 A	16 A	10 A			1	10	0.75	6	D211-84200-761N4	D211-84200-761M4	D211-84200-761V4			
		32 A	20 A			1	10	0.75	6	D221-84200-761N4	D221-84200-761M4	D221-84200-761V4			
	50 A	40 A	32 A			4	16	2.5	10	D222-84200-761N4	D222-84200-761M4	D222-84200-761V4			
			32 A	20 A	1	10	0.75	6	D241-84200-761N4	D241-84200-761M4	D241-84200-761V4				
			50 A	20 A	4	16	2.5	10	D242-84200-761N4	D242-84200-761M4	D242-84200-761V4				
	→ Main Switches:														
	Rated data (IEC 60947)					Terminal capacities (mm ²)				Padlock device N-handle black		Padlock device M-handle black		Padlockable handle V-handle silver/black	
	Operational current DC21-B I _e at					solid		flexible							
	250 V	450 V	650 V	800 V	1000 V	min	max	min	max	Order code number		Order code number		Order code number	
without PE connection link:															
20 A	16 A	10 A			1	10	0.75	6	D211-84200-760N1	D211-84200-760M1	D211-84200-760V1				
	32 A	20 A			1	10	0.75	6	D221-84200-760N1	D221-84200-760M1	D221-84200-760V1				
50 A	40 A	32 A			4	16	2.5	10	D222-84200-760N1	D222-84200-760M1	D222-84200-760V1				
			32 A	20 A	1	10	0.75	6	D241-84200-760N1	D241-84200-760M1	D241-84200-760V1				
			50 A	20 A	4	16	2.5	10	D242-84200-760N1	D242-84200-760M1	D242-84200-760V1				
with PE connection link:															
20 A	16 A	10 A			1	10	0.75	6	D211-84200-761N1	D211-84200-761M1	D211-84200-761V1				
	32 A	20 A			1	10	0.75	6	D221-84200-761N1	D221-84200-761M1	D221-84200-761V1				
50 A	40 A	32 A			4	16	2.5	10	D222-84200-761N1	D222-84200-761M1	D222-84200-761V1				
			32 A	20 A	1	10	0.75	6	D241-84200-761N1	D241-84200-761M1	D241-84200-761V1				
			50 A	20 A	4	16	2.5	10	D242-84200-761N1	D242-84200-761M1	D242-84200-761V1				

Switching programme	→ ON-OFF Switches										
	Rated data (IEC 60947)					Terminal capacities (mm ²)				M-handle silver/black	
	Operational current DC21-B I _e at					solid		flexible			
	250 V	450 V	650 V	800 V	1000 V	min	max	min	max	Order code number	

84200

2 strings

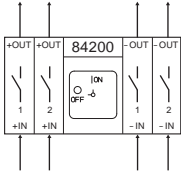

without PE connection link:

20 A	16 A	10 A			1	10	0.75	6	D211-84200-764M1	
	32 A	20 A			1	10	0.75	6	D221-84200-764M1	
50 A	40 A	32 A			4	16	2.5	10	D222-84200-764M1	
		32 A	20 A		1	10	0.75	6	D241-84200-764M1	
		50 A	20 A		4	16	2.5	10	D242-84200-764M1	

with PE connection link:

20 A	16 A	10 A			1	10	0.75	6	D211-84200-765M1	
	32 A	20 A			1	10	0.75	6	D221-84200-765M1	
50 A	40 A	32 A			4	16	2.5	10	D222-84200-765M1	
		32 A	20 A		1	10	0.75	6	D241-84200-765M1	
		50 A	20 A		4	16	2.5	10	D242-84200-765M1	

Switching programme	→ Main/Emergency-Off Switches														
	Rated data (IEC 60947)					Terminal capacities (mm ²)				Padlock device N-handle yellow/red		Padlock device M-handle yellow/red		Padlockable handle V-handle yellow/red	
	Operational current DC21-B I _e at					solid		flexible							
	250 V	450 V	650 V	800 V	1000 V	min	max	min	max	Order code number		Order code number		Order code number	

85200

3 strings

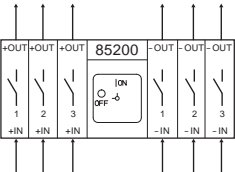

without PE connection link:

20 A	16 A	10 A			1	10	0.75	6	D211-85200-760N4	D211-85200-760M4	D211-85200-760V4
	32 A	20 A			1	10	0.75	6	D221-85200-760N4	D221-85200-760M4	D221-85200-760V4
50 A	40 A	32 A			4	16	2.5	10	D222-85200-760N4	D222-85200-760M4	D222-85200-760V4
		32 A	20 A		1	10	0.75	6	D241-85200-760N4	D241-85200-760M4	D241-85200-760V4
		50 A	20 A		4	16	2.5	10	D242-85200-760N4	D242-85200-760M4	D242-85200-760V4

with PE connection link:

20 A	16 A	10 A			1	10	0.75	6	D211-85200-761N4	D211-85200-761M4	D211-85200-761V4
	32 A	20 A			1	10	0.75	6	D221-85200-761N4	D221-85200-761M4	D221-85200-761V4
50 A	40 A	32 A			4	16	2.5	10	D222-85200-761N4	D222-85200-761M4	D222-85200-761V4
		32 A	20 A		1	10	0.75	6	D241-85200-761N4	D241-85200-761M4	D241-85200-761V4
		50 A	20 A		4	16	2.5	10	D242-85200-761N4	D242-85200-761M4	D242-85200-761V4

→ Main Switches:

Rated data (IEC 60947)	Terminal capacities (mm ²)											Padlock device N-handle black		Padlock device M-handle black		Padlockable handle V-handle silver/black	
	Operational current DC21-B I _e at					solid		flexible									
		250 V	450 V	650 V	800 V	1000 V	min	max	min	max	Order code number		Order code number		Order code number		

without PE connection link:



20 A	16 A	10 A			1	10	0.75	6	D211-85200-760N1	D211-85200-760M1	D211-85200-760V1
	32 A	20 A			1	10	0.75	6	D221-85200-760N1	D221-85200-760M1	D221-85200-760V1
50 A	40 A	32 A			4	16	2.5	10	D222-85200-760N1	D222-85200-760M1	D222-85200-760V1
		32 A	20 A		1	10	0.75	6	D241-85200-760N1	D241-85200-760M1	D241-85200-760V1
		50 A	20 A		4	16	2.5	10	D242-85200-760N1	D242-85200-760M1	D242-85200-760V1

with PE connection link:

20 A	16 A	10 A			1	10	0.75	6	D211-85200-761N1	D211-85200-761M1	D211-85200-761V1
	32 A	20 A			1	10	0.75	6	D221-85200-761N1	D221-85200-761M1	D221-85200-761V1
50 A	40 A	32 A			4	16	2.5	10	D222-85200-761N1	D222-85200-761M1	D222-85200-761V1
		32 A	20 A		1	10	0.75	6	D241-85200-761N1	D241-85200-761M1	D241-85200-761V1
		50 A	20 A		4	16	2.5	10	D242-85200-761N1	D242-85200-761M1	D242-85200-761V1

DC Disconnect Switches / Product Line D200

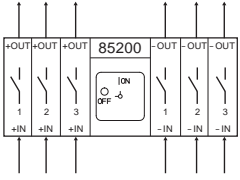
Enclosed Switches with insulated enclosure 250 × 160 × 120 mm

Switching programme	→ ON-OFF Switches									
	Rated data (IEC 60947)					Terminal capacities (mm ²)				M-handle silver/black
85200 3 strings	Operational current DC21-B I _e at					solid		flexible		 
	250 V	450 V	650 V	800 V	1000 V	min	max	min	max	
without PE connection link:										
20 A	16 A	10 A			1	10	0.75	6	D211-85200-764M1	
	32 A	20 A			1	10	0.75	6	D221-85200-764M1	
50 A	40 A	32 A			4	16	2.5	10	D222-85200-764M1	
			32 A	20 A	1	10	0.75	6	D241-85200-764M1	
			50 A	20 A	4	16	2.5	10	D242-85200-764M1	
with PE connection link:										
20 A	16 A	10 A			1	10	0.75	6	D211-85200-765M1	
	32 A	20 A			1	10	0.75	6	D221-85200-765M1	
50 A	40 A	32 A			4	16	2.5	10	D222-85200-765M1	
			32 A	20 A	1	10	0.75	6	D241-85200-765M1	
			50 A	20 A	4	16	2.5	10	D242-85200-765M1	

Further switching programmes from page 21.

Dimensions (mm):

Setup of order code number

Type	Switching progr.	Mtg. form
D242	85200	765M1
Order code no.	D242-85200-765M1	

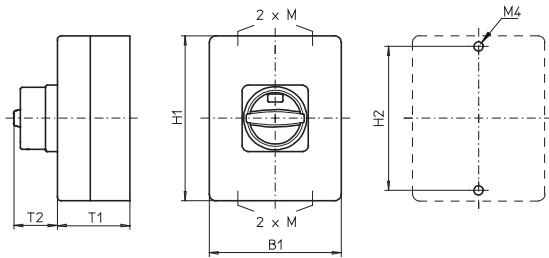

Mounting form	H1	B1	T1	T2	2×M	H2
760M1 / 760M4	250	160	120	38	25/32	235
760N1 / 760N4	250	160	120	33	25/32	235
760V1 / 760V4	250	160	120	39	25/32	235
761M1 / 761M4	250	160	120	38	25/32	235
761N1 / 761N4	250	160	120	33	25/32	235
761V1 / 761V4	250	160	120	39	25/32	235
764M1 / 765M1	250	160	120	39	25/32	235

Enclosed Switches

- Insulated enclosure (polycarbonate)
- 280 × 190 × 130 mm (H × W × D)
- Cover interlock in ON position
- 2 pole
- 250 V up to 1000 V DC
- 10 A up to 50 A
- IP66

- Main/Emergency-Off Switches
- Main Switches
- ON-OFF Switches





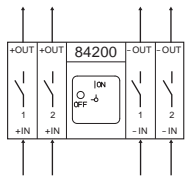

Switching programme	→ Main/Emergency-Off Switches											
	Rated data (IEC 60947)					Terminal capacities (mm ²)				Padlock device N-handle yellow/red	Padlock device M-handle yellow/red	Padlockable handle V-handle yellow/red
84200 2 strings	Operational current DC21-B I _e at					solid		flexible				
	250 V	450 V	650 V	800 V	1000 V	min	max	min	max	Order code number	Order code number	Order code number
	20 A	16 A	10 A			1	10	0.75	6	D211-84200-763N4	D211-84200-763M4	D211-84200-763V4
		32 A	20 A			1	10	0.75	6	D221-84200-763N4	D221-84200-763M4	D221-84200-763V4
	50 A	40 A	32 A			4	16	2.5	10	D222-84200-763N4	D222-84200-763M4	D222-84200-763V4
			32 A	20 A		1	10	0.75	6	D241-84200-763N4	D241-84200-763M4	D241-84200-763V4
			50 A	20 A		4	16	2.5	10	D242-84200-763N4	D242-84200-763M4	D242-84200-763V4
→ Main Switches:												
	Rated data (IEC 60947)					Terminal capacities (mm ²)				Padlock device N-handle black	Padlock device M-handle black	Padlockable handle V-handle silver/black
	Operational current DC21-B I _e at					solid		flexible				
	250 V	450 V	650 V	800 V	1000 V	min	max	min	max	Order code number	Order code number	Order code number
	20 A	16 A	10 A			1	10	0.75	6	D211-84200-763N1	D211-84200-763M1	D211-84200-763V1
		32 A	20 A			1	10	0.75	6	D221-84200-763N1	D221-84200-763M1	D221-84200-763V1
	50 A	40 A	32 A			4	16	2.5	10	D222-84200-763N1	D222-84200-763M1	D222-84200-763V1
			32 A	20 A		1	10	0.75	6	D241-84200-763N1	D241-84200-763M1	D241-84200-763V1
			50 A	20 A		4	16	2.5	10	D242-84200-763N1	D242-84200-763M1	D242-84200-763V1
→ ON-OFF Switches												
	Rated data (IEC 60947)					Terminal capacities (mm ²)				M-handle silver/black		
	Operational current DC21-B I _e at					solid		flexible				
	250 V	450 V	650 V	800 V	1000 V	min	max	min	max	Order code number		
	20 A	16 A	10 A			1	10	0.75	6	D211-84200-766M1		
		32 A	20 A			1	10	0.75	6	D221-84200-766M1		
	50 A	40 A	32 A			4	16	2.5	10	D222-84200-766M1		
			32 A	20 A		1	10	0.75	6	D241-84200-766M1		
			50 A	20 A		4	16	2.5	10	D242-84200-766M1		

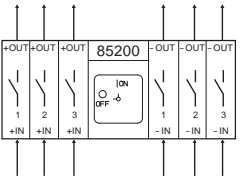
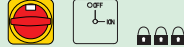

DC Disconnect Switches / Product Line D200

Enclosed Switches with insulated enclosure 280 × 190 × 130 mm

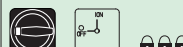
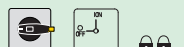
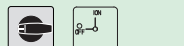
Switching programme		→ Main/Emergency-Off Switches										
85200 3 strings 	Rated data (IEC 60947)	Terminal capacities (mm ²)								Padlock device N-handle yellow/red	Padlock device M-handle yellow/red	Padlockable handle V-handle yellow/red
	Operational current DC21-B I _e at	solid				flexible						
	250 V	450 V	650 V	800 V	1000 V	min	max	min	max	Order code number	Order code number	Order code number
	20 A	16 A	10 A			1	10	0.75	6	D211-85200-763N4	D211-85200-763M4	D211-85200-763V4
		32 A	20 A			1	10	0.75	6	D221-85200-763N4	D221-85200-763M4	D221-85200-763V4
	50 A	40 A	32 A			4	16	2.5	10	D222-85200-763N4	D222-85200-763M4	D222-85200-763V4
			32 A	20 A	1	10	0.75	6	D241-85200-763N4	D241-85200-763M4	D241-85200-763V4	
			50 A	20 A	4	16	2.5	10	D242-85200-763N4	D242-85200-763M4	D242-85200-763V4	
→ Main Switches:												
	Rated data (IEC 60947)	Terminal capacities (mm ²)								Padlock device N-handle black	Padlock device M-handle black	Padlockable handle V-handle silver/black
	Operational current DC21-B I _e at	solid				flexible						
	250 V	450 V	650 V	800 V	1000 V	min	max	min	max	Order code number	Order code number	Order code number
	20 A	16 A	10 A			1	10	0.75	6	D211-85200-763N1	D211-85200-763M1	D211-85200-763V1
		32 A	20 A			1	10	0.75	6	D221-85200-763N1	D221-85200-763M1	D221-85200-763V1
	50 A	40 A	32 A			4	16	2.5	10	D222-85200-763N1	D222-85200-763M1	D222-85200-763V1
			32 A	20 A	1	10	0.75	6	D241-85200-763N1	D241-85200-763M1	D241-85200-763V1	
			50 A	20 A	4	16	2.5	10	D242-85200-763N1	D242-85200-763M1	D242-85200-763V1	
→ ON-OFF Switches												
	Rated data (IEC 60947)	Terminal capacities (mm ²)								M-handle silver/black		
	Operational current DC21-B I _e at	solid				flexible						
	250 V	450 V	650 V	800 V	1000 V	min	max	min	max	Order code number		
	20 A	16 A	10 A			1	10	0.75	6	D211-85200-766M1		
		32 A	20 A			1	10	0.75	6	D221-85200-766M1		
	50 A	40 A	32 A			4	16	2.5	10	D222-85200-766M1		
			32 A	20 A	1	10	0.75	6	D241-85200-766M1			
			50 A	20 A	4	16	2.5	10	D242-85200-766M1			

Further switching programmes from page 21.

Dimensions (mm):

Setup of order code number		
Type	Switching progr.	Mtg. form
D242	85200	766M1
Order code no. D242-85200-766M1		

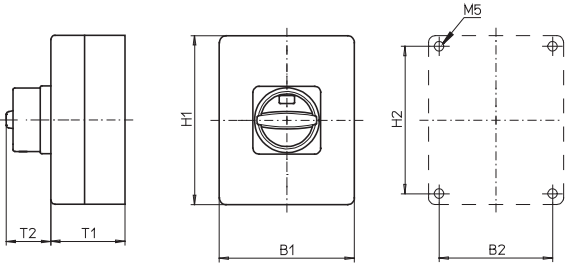
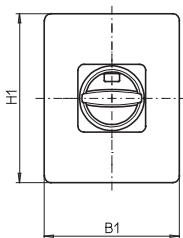
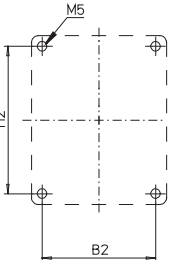



Mounting form	H1	B1	T1	T2	H2	B2
763M1 / 763M4	280	190	130	38	254	164
763N1 / 763N4	280	190	130	33	254	164
763V1 / 763V4 / 766M1	280	190	130	39	254	164

Switching diagrams

2 pole, 1 string:

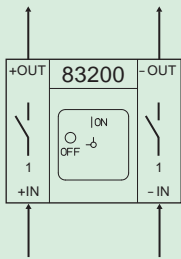
Switching programme 83200



Switching programme 83300

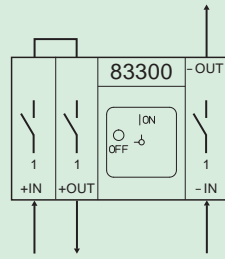

Switching programme 89300

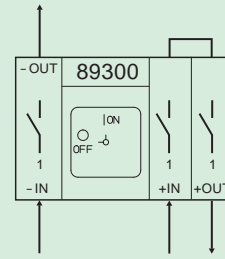

2 pole, 2 strings:

Switching programme 84200

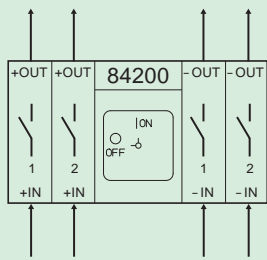

2 pole, 3 strings:

Switching programme 85200

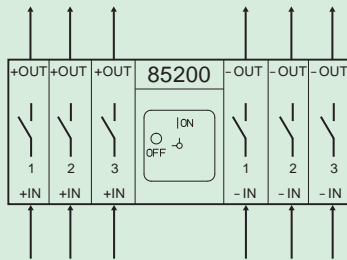

2 pole, 4 strings:

Switching programme 86200 (mechanical lifespan 10×10^3)

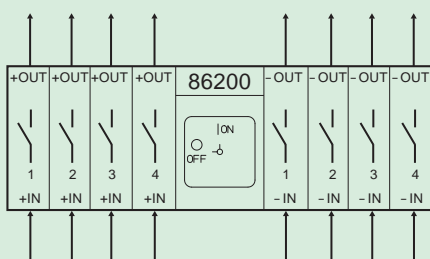

DC Disconnect Switches / Product Line D200

Technical Information Additional modules / Accessories

Auxiliary contact modules (factory-attached only)

Module right	Switching programme w/o auxiliary contact module	Switching programme w/ auxiliary contact module
--------------	---	--

Auxiliary contact module 1 n/o + 1 n/c

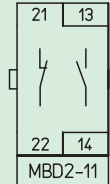

83200	83211
83300	83311
84200	84211
85200	85211
86200	86211

Side mounted auxiliary contacts are securely mounted on the right side of the switch module, this then increases the overall width by 9 mm. Please select your required switching programme from the previous pages, this will provide you with the initial circuit. The last two digits of the switching programme will then change according to the auxiliary module specified as per your requirement similar to the example below:

Auxiliary contact module 2 n/o



83200	83220
83300	83320
84200	84220
85200	85220
86200	86220

Example:

D241-**84200**-003M1
+ Auxiliary contact module (1 n/o, 1 n/c)
= D241-**84211**-003M1

Auxiliary contact module 2 n/c

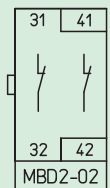

83200	83202
83300	83302
84200	84202
85200	85202
86200	86202

Modular shaft extensions for mounting forms with door clutch (please order separately)

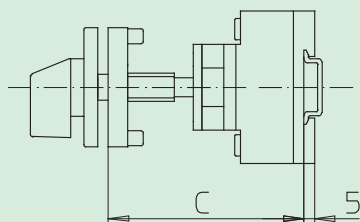
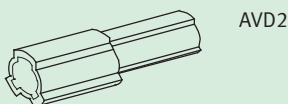

Dimension C	number	Order code no.
092 ... 109 mm	–	–
110 ... 134 mm	1	AVD2
135 ... 159 mm	2	AVD2
160 ... 184 mm	3	AVD2
185 ... 209 mm	4	AVD2

Internal depth: Inside of door to top of DIN rail

Rated data

Type		D211	D221	D222	D241	D242	
Operational voltage U_e	(V DC)	650	650	650	1000	1000	
Overvoltage category		III	III	III	III	III	
Pollution degree		3	3	3	3	3	
Breaking capacity	(A)	75	75	75	75	75	
Isolating characteristics (to EN 60947)	(up to ... V AC/V DC)	1000	1000	1000	1000	1000	
Switching angle		90°	90°	90°	90°	90°	
Contacts (Current paths) (max.)		8	8	8	8	8	
Current heat loss per contact at I_u	(W)	0.8	0.8	0.8	0.8	0.8	
Arc quenching time	(ms)	5	5	5	5	5	
Terminal capacity							
	solid or stranded	min. (mm ²)	1	1	4	1	4
		max. (mm ²)	10	10	16	10	16
	flexible or multiwire (including ferrule)	min. (mm ²)	0,75	0,75	2,5	0,75	2,5
		max. (mm ²)	6	6	10	6	10
Terminal connecting lines		Copper wires only					
Thread dimensions for terminal screw		M4	M4	M4	M4	M4	
Terminal tightening torque	min. (Nm)	1.2	1.2	1.2	1.2	1.2	
	max. (Nm)	2.5	2.5	2.5	2.5	2.5	
Operational current I_e (A)	250 V	20		50			
	450 V	16	32	40			
DC-21B	2 pole	650 V	10	20	32	50	
		800 V				32	50
		1000 V				20	20
	2 pole (positive pole 2 contacts in series)	800 V					50
		1000 V				32	50
DC-21A	2 pole	250 V	16	32	50		
		450 V	10	25	40		
		650 V	6	16	20		50
		800 V				32	32
		1000 V				6	
	2 pole (positive pole 2 contacts in series)	800 V					50
		1000 V				32	50

General

General		D211	D221	D222	D241	D242
Standards		IEC 60947 / EN 60947 / VDE 0660				
Mechanical lifespan	2–6 contacts (1–3 strings)	20×10 ³	20×10 ³	20×10 ³	20×10 ³	20×10 ³
	8 contacts (4 strings)	10×10 ³	10×10 ³	10×10 ³	10×10 ³	10×10 ³
Max. operating frequency / h		50	50	50	50	50
Climatic resistance (damp heat)	constant	to DIN IEC 60068-2-3				
	cyclic	to DIN IEC 60068-2-30				
Ambient temperature (min. / max.)	open (°C)	–25 / +50				
	enclosed (°C)	–25 / +40				
Mounting position		as required				
Mechanical shock resistance (shock duration 20ms)	(g)	>25	>25	>25	>25	>25



If you have any further questions, just contact us.

Sälzer Electric GmbH
Matthiasstraße 16
D-57482 Wenden (Germany)

Phone +49(0)2762 614-110
Fax +49(0)2762 614-100
info@salzer.de

