

# 1 Phase electronic contactor (SC 1)



- Rated operational voltage up to 600VAC 50/60 Hz
- Rated operational current up to 15/30A/50/63A AC-1
- Control voltage from 5-24 VDC or 24-230 VAC/DC
- Compact modular design 22.5, 45, or 90 mm
- LED Status indication
- Meets EN 60947-4-3 requirements
- Requires no additional components
- Built-in varistor protection
- IP-20 Protection

## Item selection and technical specifications

Load AC-1/51 Heating - element	Load AC-3 Motor	Load AC-55b Lamp	Load AC-56a Trans-former	Control voltage	Item number by 12-240VAC 50/60Hz Line Voltage	Item number by 24-480VAC 50/60Hz Line Voltage	Item number by 24-600VAC 50/60Hz Line Voltage		Modul-breite
15A	15A 10A by 600 VAC	15A	15A	5-24 VDC 24-230 VAC/DC	SC 1 DD 2315 SC 1 DA 2315	SC 1 DD 4015 SC 1 DA 4015	<b>SC 1 DD 6015</b> <b>SC 1 DA 6015</b>		22.5mm 22.5mm
30A	15A	20A	15A	5-24 VDC 24-230 VAC/DC	SC 1 DD 2330 SC 1 DA 2330	SC 1 DD 4030 SC 1 DA 4030			45mm 45mm
50A	15A	20A	15A	5-24 VDC 24-230 VAC/DC		SC 1 DD 4050 SC 1 DA 4050			90mm 90mm
63A	30A	40A	30A	5-24 VDC 24-230 VAC/DC		<b>SC 1 DD 4063 *</b> <b>SC 1 DA 4063 *</b>	<b>SC 1 DD 6063 *</b>		90mm 90mm

## Output load specification

Leakage current	1mA ACmax.	Min. operational current	10mA
Duty cycle	100%		

## Control terminal specifications

SC 1 DD XXXX (DC)		SC 1 DA XXXX (AC/DC)	
Control voltage	5-24 VDC	Control voltage	24-230 VAC/DC
Pick-up voltage max.	4.25 VDC	Pick-up voltage max.	20.4 VAC/DC
Drop-out voltage min.	1.5 VDC	Drop-out voltage min.	7.2 VAC/DC
Control current voltage	15 mA@24 VDC	Control current / power max.	6 mA / 1.5VA@24 VDC
Max. control voltage	32 VDC	Max. control voltage	253 VAC/DC
Response time max.	1/2 cycle	Response time max.	1 cycle

## Thermal specification

Power dissipation for continuous operation PDmax	1.2 W/A	Operation in ambient temperatures exceeding 40°C is possible if the power dissipation is limited either by reducing the steady-state current or by reducing the duty-cycle as shown in the table. Max.cycle time 15min.		
Power dissipation for intermittent operation PD	1.2 W/A x dutycycle			
Cooling method	Natural convection	By 40°C	By 50°C	By 60°C
Mounting	Vertical +/-30°	100% load Duty-cycle 100%	80% load Duty-cycle max. 0.8	70% load Duty-cycle max. 0.65
Operating temperature range EN 60947-4-3	-5°C to 40°C			
Max. operating temperature with current derating	60°C			
Storage temperature EN 60947-4-3	-20°C to 80°C			

## Environment

Degree of protection	IP 20	Pollution degree	3
----------------------	-------	------------------	---

## Approval

cUL Std No. 508. **Not approved SC1 DX 6015-1 + SC1 DX XX63 + SC1 DX 69XX**  
 UL: Use thermal overload protection as required by the National Electric Code. When protected by a non-time delay K5 or H Class fuse, rated 266% of motor FLA, this device is rated for use on a circuit capable of delivering not more than 5,000 rms. symmetrical amperes, 600 V maximum. Maximum surrounding temperature 40°C.

## Insulation specifications

Rated insulation voltage	Ui 660 Volt	cUL Std No. 508. <b>Not approved SC1 DX 6015-1 + SC1 DX XX63 + SC1 DX 69XX</b> UL: Use thermal overload protection as required by the National Electric Code. When protected by a non-time delay K5 or H Class fuse, rated 266% of motor FLA, this device is rated for use on a circuit capable of delivering not more than 5,000 rms. symmetrical amperes, 600 V maximum. Maximum surrounding temperature 40°C.
Rated insulation voltage #	Ui 690 Volt	
Rated impulse withstand voltage	Uimp. 4 kVolt	
Installation category	III	

# 1 Phase electronic contactor (SC 1)

## Wiring specifications

SC 1 DX XXXX

11-12: for UP62 or other wiring purposes

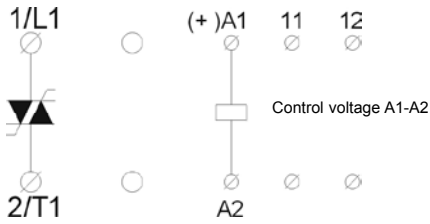

## Short-circuit protection by fuses

Two type of short-circuit protection can be used:

Short-circuit protection by fuses

Fuse short-circuit protection is divided into 2 levels Type 1 or Type 2

Co-ordination Type 1: Short-circuit protects the installation

SC 1 DX XX15	Protection max. 50A gL/gG
SC 1 DX XX15-1	Protection max. 50A gL/gG
SC 1 DX XX30	Protection max. 50A gL/gG
SC 1 DX XX50	Protection max. 50A gL/gG
SC 1 DX XX63	Protection max. 80A gL/gG

Co-ordination Type 2: Short-circuit protects the installation and the semi conductors inside the motor controller

SC 1 DX 2315 / 4015	Protection max. i <sub>t</sub> of the fuse	1800 A <sup>2</sup> s
SC 1 DX 6X15 / 6X15-1	Protection max. i <sub>t</sub> of the fuse	610 A <sup>2</sup> s
SC 1 DX 2330 / 4030	Protection max. i <sub>t</sub> of the fuse	1800 A <sup>2</sup> s
SC 1 DX 6X30	Protection max. i <sub>t</sub> of the fuse	6300 A <sup>2</sup> s
SC 1 DX 2350 / 4050	Protection max. i <sub>t</sub> of the fuse	1800 A <sup>2</sup> s
SC 1 DX 6X50	Protection max. i <sub>t</sub> of the fuse	6300 A <sup>2</sup> s
SC 1 DX XX63	Protection max. i <sub>t</sub> of the fuse	6300 A <sup>2</sup> s

Fuses from e.g. Ferraz, Siba, Bussmann can be used as short-circuit protection Type 2

More information concerning Co-ordination Type 2 see page 45

## Short Circuit Protection with standard fuse for SC1DX..15

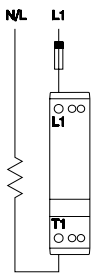

Short Circuit Protection for SC1 DX XX15 (15 A Type)

Co-ordination Type 2  
Line Voltage up to 480 V. Due to the oversized Output SCR's the contactor is fully protected by a standard fuse up to 16 A. Operating Class gL/gG..

No need for Ultra Fast Fuses  
Max Load at 230 V: 3.5 kW  
Max Load at 400 V: 6.0 kW  
Max Load at 480 V: 7.2 kW

## EMC

This component meets the requirements of the product standard EN 60947-4-3 and is CE marked according to this standard. This products has been designed for class A equipment. Use of the product in domestic environments may cause radio interference, in which case the user may be required to employ additional mitigation methods.

## Utilisation Categories (EN 60947-4-3)

AC - 51	Switching of resistive loads
AC - 55a	Switching of electric discharge lamp controls
AC - 55b	Switching of incandescent lamps
AC - 56a	Switching of transformers

## Thermal overload protection (see also page 44)

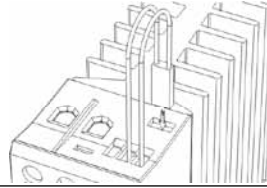

Optional thermal overload protection is possible by inserting a thermostat in a slot on the right hand side of the electronic contactor. Type number UP62

Example 1

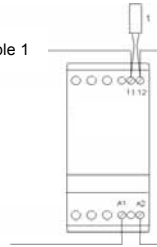

The thermostat can be connected in series with the control circuit of the electronic contactor. When the temperature of the heatsink exceeds 90°C the electronic contactor will switch Off.

Note:

When the temperature has dropped approx. 30°C the electronic contactor will automatically be switched on again.

Example 2

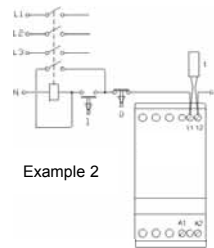

The thermostat is connected in series with the control circuit of the main contactor.

When the temperature of the heatsink exceeds 90°C the main contactor will switch Off.

Note:

A manual reset is necessary to restart this circuit.

## Common Short Circuit Protection SC 1 DX XX15

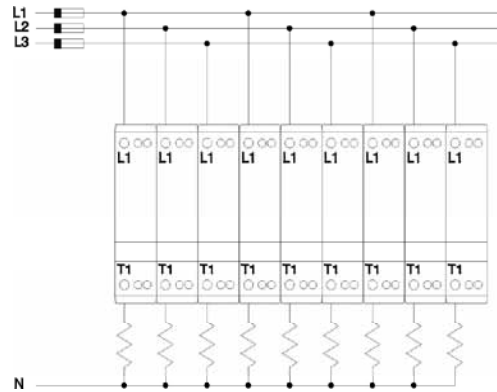

## Short Circuit Protection for several Contactors e.g. SC1 DX XX15

Max Fuse 50 A gL/gG for Short Circuit  
Coordination type 1

SC1 DX 2315 / SC 1 DX 4015  
Max Fuse 1800 A<sup>2</sup>s  
e.g. Siemens SILIZED 5SD4 60  
Short Circuit Coordination type 2

SC1 DX 6015  
Max Fuse 450 A<sup>2</sup>s  
e.g. Siemens SILIZED 5SD4 50  
Short Circuit Coordination type 2

## Dimensions (see also page 44)

Type	H	D	W
22.5 mm module	94 mm	124.3 mm	22.5 mm
45 mm module	94 mm	124.3 mm	45 mm
90 mm module	94 mm	124.3 mm	90 mm

## Mounting and cable wiring information

Mounting information see page 44 / Cable wiring see page 45

# 1 Phase dual pole electronic contactor (SC 2)



- Rated operational voltage up to 600VAC 50/60 Hz
- Rated operational current up to 30 / 50A AC-1 (accumulated)
- Control voltage from 5-24 VDC or 24-230 VAC/DC
- Compact modular design 45 or 90 mm
- LED Status indication
- Meets EN 60947-4-3 requirements
- Requires no additional components
- Built-in varistor protection
- IP-20 Protection

## Item selection and technical specifications

Load AC-1/51 Heating-element	Load AC-3 Motor	Load AC-55b Lamp	Load AC-56a Transformer	Control voltage	Item number by 24-480VAC 50/60Hz Line Voltage	Module-width
30A <sup>1</sup> accumulated	15A	20A	15A	5-24 VDC	SC 2 DD 4030	45mm
				24-230 VAC/DC	SC 2 DA 4030	45mm
50A <sup>1</sup> accumulated	15A	20A	15A	5-24 VDC	SC 2 DD 4050	90mm
				24-230 VAC/DC	SC 2 DA 4050	90mm

<sup>1</sup>The indicated loads are accumulated. E.g. the total sum of the current in L1 & L2 (1x30A or 2x15A )

## Output load specification

Leakage current	1mA ACmax.	Min. operational current	10mA
Duty cycle	100%		

## Control terminal specifications

SC 2 DD XXXX (DC)	SC 2 DA XXXX (AC/DC)
Control voltage	Control voltage
Pick-up voltage max.	Pick-up voltage max.
Drop-out voltage min.	Drop-out voltage min.
Control current voltage	Control current / power max.
Max. control voltage	Max. control voltage
Response time max.	Response time max.

## Thermal specification

Power dissipation for continuous operation PDmax	2.2 W/A accumulated	Operation in ambient temperatures exceeding 40°C is possible if the power dissipation is limited either by reducing the steady-state current or by reducing the duty-cycle as shown in the table. Max.cycle time 15min.		
Power dissipation for intermittent operation PD	2.2 W/A x dutycycle			
Cooling method	Natural convection	By 40°C	By 50°C	By 60°C
Mounting	Vertical +/-30°	100% load Duty-cycle 100%	80% load Duty-cycle max. 0.8	70% load Duty-cycle max. 0.65
Operating temperature range EN 60947-4-2	-5°C to 40°C	<b>Environment</b>		
Max. operating temperature with current derating	60°C	Degree of protection	IP 20	Pollution degree
Storage temperature EN 60947-4-2	-20°C to 80°C			3

## Insulation specifications

Rated insulation voltage	Ui 660 Volt	<b>Approval</b> ULc Std No. 508 UL: Use thermal overload protection as required by the National Electric Code. When protected by a non-time delay K5 or H Class fuse, rated 266% of motor FLA, this device is rated for use on a circuit capable of delivering not more than 5,000 rms. symmetrical amperes, 600 V maximum. Maximum surrounding temperature 40°C.
Rated impulse withstand voltage	Uimp. 4 kVolt	
Installation category	III	

# 1 Phase dual pole electronic contactor (SC 2)

## Wiring specifications

SC 2 DX XXXX

11-12: for UP62 or other wiring purposes

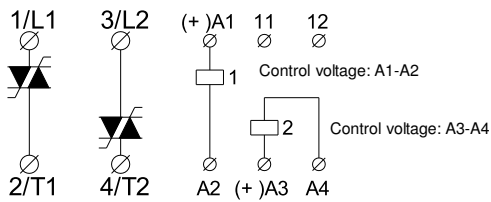

## Short-circuit protection by fuses

Two type of short-circuit protection can be used:

### Short-circuit protection by fuses

Short-circuit protection is divided into 2 levels **Type 1 or Type 2**

#### Co-ordination Type 1: Short-circuit protects the installation

SC 2 DX XX30 Protection max. 50A gL/gG  
 SC 2 DX XX50 Protection max. 50A gL/gG

#### Co-ordination Type 2: Short-circuit protects the installation and the semiconductors inside the motor controller

SC 2 DX XX30 Protection max.  $i^2t$  of the fuse 1800 A<sup>2</sup>S  
 SC 2 DX XX50 Protection max.  $i^2t$  of the fuse 1800 A<sup>2</sup>S

Fuses from e.g. Ferraz, Siba, Bussmann can be used as short-circuit protection Type 2

More information concerning Co-ordination Type 2 see page 45

## EMC

This component meets the requirements of the product standard EN 60947-4-3 and is CE marked according to this standard. This products has been designed for class A equipment. Use of the product in domestic environments may cause radio interference, in which case the user may be required to employ additional mitigation methods.

## Dimensions (se also page 44)

Type	H	D	W
45 mm module	94 mm	124.3 mm	45 mm
90 mm module	94 mm	124.3 mm	90 mm

## Thermal overload protection (see also page 44)

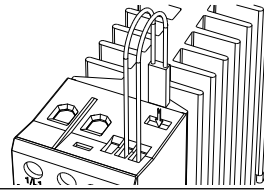

Optional thermal overload protection is possible by inserting a thermostat in a slot on the right hand side of the electronic contactor. Type number UP62

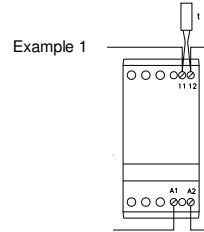

The thermostat can be connected in series with the control circuit of the electronic contactor. When the temperature of the heatsink exceeds 90°C the electronic contactor will switch Off.

### Note:

When the temperature has dropped approx. 30°C the electronic contactor will automatically be switched on again.

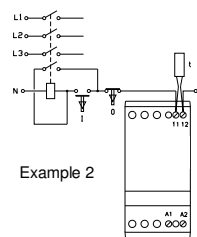

The thermostat is connected in series with the control circuit of the main contactor. When the temperature of the heatsink exceeds 90°C the main contactor will switch Off.

When the temperature of the heatsink exceeds 90°C the main contactor will switch Off.

### Note:

A manual reset is necessary to restart this circuit.

## Utilisation Categories (EN 60947-4-3)

- AC - 51 Switching of resistive loads
- AC - 55a Switching of electric discharge lamp controls
- AC - 55b Switching of incandescent lamps
- AC - 56a Switching of transformers

## Mounting and cable wiring information

Mounting information see page 44 / Cable wiring see page 45

## 3 Phase electronic contactor (SC 3)



- Rated operational voltage up to 600VAC 50/60 Hz
- Rated operational current up to 10 ,15 and 20 A AC-1
- Control voltage from 5-24 VDC or 24-230 VAC/DC
- Compact modular design 45 or 90 mm
- LED Status indication
- Meets EN 60947-4-3 requirements
- Requires no additional components
- Built-in varistor protection
- IP-20 Protection

### Item selection and technical specifications

Load AC-1/51 Heating-element	Load AC-3 Motor	Load AC-55b Lamp	Load AC-56a Transformer	Control voltage	Item number by 24-480VAC 50/60Hz Line Voltage	Item number by 24-600VAC 50/60Hz Line Voltage	Module-width
10A	10A	10A	5A	5-24 VDC 24-230 VAC/DC	SC 3 DD 4010 SC 3 DA 4010	SC 3 DD 6010 SC 3 DA 6010	45mm 45mm
20A	10A	10A	5A	5-24 VDC 24-230 VAC/DC	SC 3 DD 4020 SC 3 DA 4020		90mm 90mm

### Output load specification

Leakage current	1mA ACmax.	Min. operational current	10mA
Duty cycle	100%		

### Control terminal specifications

SC 3 DD XXXX (DC)		SC 3 DA XXXX (AC/DC)	
Control voltage	5-24 VDC	Control voltage	24-230 VAC/DC
Pick-up voltage max.	4.25 VDC	Pick-up voltage max.	20.4 VAC/DC
Drop-out voltage min.	1.5 VDC	Drop-out voltage min.	7.2 VAC/DC
Control current voltage	15 mA@24 VDC	Control current / power max.	6mA / 1.5VA@24 VDC
Max. control voltage	32 VDC	Max. control voltage	253 VAC/DC
Response time max. (ON/OFF)	1/2 cycle	Response time max. (ON/OFF)	1 cycle

### Thermal specification

Power dissipation for continuous operation PDmax	3.3 W/A	Operation in ambient temperatures exceeding 40°C is possible if the power dissipation is limited either by reducing the steady-state current or by reducing the duty-cycle as shown in the table. Max.cycle time 15min.		
Power dissipation for intermittent operation PD	3.3 W/A x dutycycle			
Cooling method	Natural convection	By 40°C	By 50°C	By 60°C
Mounting	Vertical +/-30°	100% load Duty-cycle 100%	80% load Duty-cycle max. 0.8	70% load Duty-cycle max. 0.65
Operating temperature range EN 60947-4-3	-5°C to 40°C	<b>Environment</b>		
Max. operating temperature with current derating	60°C	Degree of protection	IP 20	Pollution degree
Storage temperature EN 60947-4-3	-20°C to 80°C			3

### Insulation specifications

Rated insulation voltage	Ui 660 Volt	cUL Std No. 508 ( <b>Not approved SC3DX4015</b> ) UL: Use thermal overload protection as required by the National Electric Code. When protected by a non-time delay K5 or H Class fuse, rated 266% of motor FLA, this device is rated for use on a circuit capable of delivering not more than 5,000 rms. symmetrical amperes, 600 V maximum. Maximum surrounding temperature 40°C.
Rated impulse withstand voltage	Uimp. 4 kVolt	
Installation category	III	

# 3 Phase electronic contactor (SC 3)

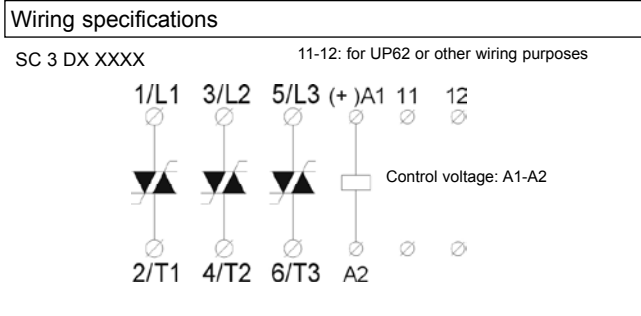

**Short-circuit protection by fuses**

Two type of short-circuit protection can be used:

**Short-circuit protection by fuses**  
Short-circuit protection is divided into 2 levels Type 1 or Type 2

**Co-ordination Type 1:** Short-circuit protects the installation  
SC 3 DX XX10      Protection max. 50A gL/gG

SC 3 DX XX20      Protection max. 50A gL/gG

**Co-ordination Type 2:** Short-circuit protects the installation and the semiconductors inside the motor controller  
SC 3 DX XX10      Protection max.  $i^2t$  of the fuse 610 A<sup>2</sup>S

SC 3 DX XX20      Protection max.  $i^2t$  of the fuse 610 A<sup>2</sup>S

Fuses from e.g. Ferraz, Siba, Bussmann can be used as short-circuit protection Type 2

More information concerning Co-ordination Type 2 see page 45

**EMC**

This component meets the requirements of the product standard EN 60947-4-3 and is CE marked according to this standard. This products has been designed for class A equipment. Use of the product in domestic environments may cause radio interference, in which case the user may be required to employ additional mitigation methods.

**Mounting and cable wiring information**

Mounting information see page 44 / Cable wiring see page 45

**Thermal overload protection (see also page 44)**

Optional thermal overload protection is possible by inserting a thermostat in a slot on the right hand side of the electronic contactor. Type number UP62

**Example 1**

The thermostat can be connected in series with the control circuit of the electronic contactor. When the temperature of the heatsink exceeds 90°C the electronic contactor will switch Off.  
Note: When the temperature has dropped approx. 30°C the electronic contactor will automatically be switched on again.

**Example 2**

The thermostat is connected in series with the control circuit of the main contactor. When the temperature of the heatsink exceeds 90°C the main contactor will switch Off.  
Note: A manual reset is necessary to restart this circuit.

**Utilisation Categories (EN 60947-4-3)**

AC - 51      Switching of resistive loads

AC - 55a      Switching of electric discharge lamp controls

AC - 55b      Switching of incandescent lamps

AC - 56a      Switching of transformers

**Dimensions (se also page 44)**

Type	H	D	W
45 mm module	94 mm	124.3 mm	45 mm
90 mm module	94 mm	124.3 mm	90 mm



# 3-Phase electronic reversing contactor

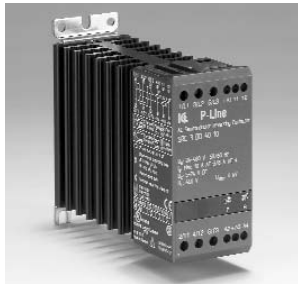

- Rated operational voltage up to 480 VAC 50/60Hz
- Rated operational current up to 10A AC-3
- Two independent control inputs with mutual interlock
- Control voltage from 5-24VDC or 24-230VAC/DC
- LED Status indication
- Meets EN 60947-4-2 requirements
- Requires only 45 mm DIN rail space

## Item selection and technical specifications

Load ratings AC-53 motor load stand. AC-4 motor load inching / plugging	Control voltage		Item number by 24-480VAC 50/60Hz Line Voltage		Module-width
10A AC-53 / 8A AC-4	5-24 VDC		SRC 3 DD 4010		45mm
10A AC-53 / 8A AC-4	24-230 VAC/DC		SRC 3 DA 4010		45mm

## Output load specification

Operational current AC-3	10A	Leakage current	5mA ACmax.
Operational current AC-4	8A	Min. operational current	50mA
Duty cycle	100%		

## Control terminal specifications

SRC 3 DD 4010		SRC 3 DA 4010	
Control voltage	5 - 24 VDC	Control voltage	24- 230 VAC/DC
Pick-up voltage max.	4.25 VDC	Pick-up voltage max.	20.4 VAC/DC
Drop-out voltage min.	1.5 VDC	Drop-out voltage min.	7.2 VAC/DC
Control current	25mA @ 4VDC	Control current / power max.	6mA / 1.5VA@24VDC
Response time max.	1/2 cycle	Response time max.	1cycle
Interlock time max.	80 msec.	Interlock time max.	150 msec.

## Thermal specification

Power dissipation for continuous operation PDmax	2.2 W/A	Operation in ambient temperatures exceeding 40°C is possible if the power dissipation is limited either by reducing the steady-state current or by reducing the duty-cycle of the contactor as shown in the table. Max.cycle time 15min.
Power dissipation for intermittent operation PD	2.2 W/A x dutycycle	
Cooling method	Natural convection	
Mounting	Vertical +/-30°	
Operating temperature range EN 60947-4-2	-5C° to 40°C	
Storage temperature EN 60947-4-2	-20C° to 80°C	
Max. operating temperature with current derating	60°C	

## Insulation specifications

Rated insulation voltage	Ui 660 Volt
Rated impulse withstand voltage	Uimp. 4 kVolt
Installation category	III

## Functional diagram

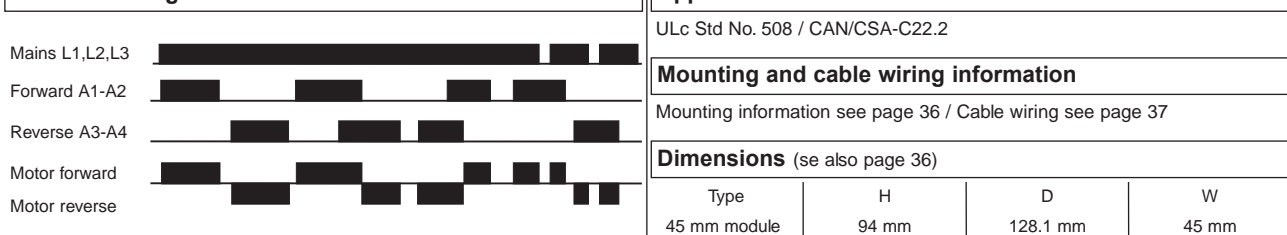

## Approval

ULc Std No. 508 / CAN/CSA-C22.2

## Mounting and cable wiring information

Mounting information see page 36 / Cable wiring see page 37

## Dimensions (se also page 36)

Type	H	D	W
45 mm module	94 mm	128.1 mm	45 mm

# 3-Phase electronic reversing contactor

## Wiring specifications

SRC 3 DX 4010

For UP 62 or other wiring purposes

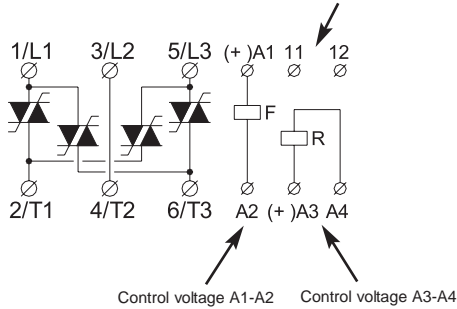

## Combining Reversing Electronic Contactor & Soft Starter

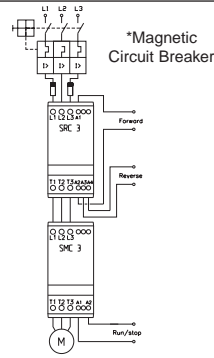

### Soft-reversing of motors up to 10A

A Soft-Reversing of a motor can easily be achieved by connecting a reversing relay to the Soft Starter. The reversing relay type SRC 3 DX will determine the direction of rotation Forward or Reverse and the Soft Starter type SMC 33 DA XXXX will perform soft-starting and soft-stopping of the motor. If soft-stop is not required the application can be simplified by connecting the control circuit of the Soft Starter to the main terminals as shown under Line Controlled Soft-Start. A delay of approx. 0.5 sec. between forward and reverse control signal must be allowed to avoid influence from the voltage generated by the motor during turn Off.

## Short-circuit protection by circuit breaker or fuses

Two type of short-circuit protection can be used:

- Short-circuit protection by circuit breaker.
- Short-circuit protection by fuses.

Short-circuit protection is divided into 2 levels **Type 1** or **Type 2**

**Co-ordination Type 1:** Short-circuit protects the installation

**Co-ordination Type 2:** Short-circuit protects the installation and the semiconductors inside the motor controller

### a) Short-circuit protection by circuit breaker

A 3-Phase motor with correctly installed and adjusted overload relay will not short circuit totally to earth or between the 3 phases. Part of the winding will normally limit the short circuit current to a value that will cause instantaneous magnetic tripping of the circuit breaker without damage to the electronic contactor. The magnetic trip response current is approx. 11 times the max. adjustable current.

### b) Short-circuit protection by fuses

- Type 1: SRC 3 DX 4010 Protection max. 50 A gL/gG  
 Type 2: SRC 3 DX 4010 Protection max. 12t of the fuse 610 A2S

Fuses from e.g. Ferraz, Siba, Bussmann can be used as short-circuit protection Type 2  
 More information concerning Co-ordination Type 2 see page 37

## Overload Protection in Motor Control Reversing

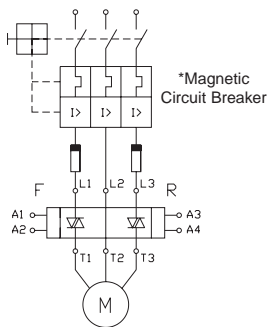

Overload protection of the motor is easily achieved by installing a manual thermal magnetic circuit breaker on the supply side of the motor. The circuit breaker provides means for padlocking and the necessary clearance for use as a circuit isolator according to EN 60204-1.

Adjust the current limit on the MCB according to the rated nominal current of the motor  
 \*Use UL approved Magnetic Circuit Breaker or UL specified back-up fuse type K5 or H Class

## Thermal overload protection (see also page 36)

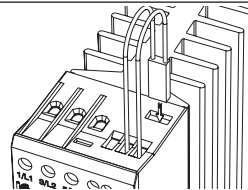

Optional thermal overload protection is possible by inserting a thermostat in a slot on the right hand side of the contactor. Type number UP62

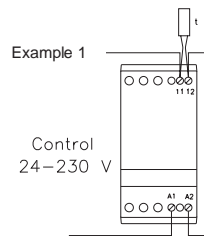

The thermostat can be connected in series with the control circuit of the contactor. When the temperature of the heatsink exceeds 90°C the soft starter will switch Off.  
**Note:** When the temperature has dropped approx. 30°C the contactor will automatically be switched on again.

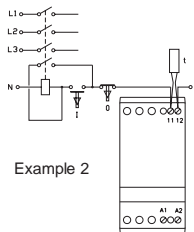

The thermostat is connected in series with the control circuit of the main contactor. When the temperature of the heatsink exceeds 90°C the main contactor will switch Off. A manual reset is necessary to restart this circuit.

## Utilisation Categories EN60947-4-2

**Category AC-53:** Starting, switching off motors during running

**Category AC-4:** Starting, plugging, reversing the motors rapidly while the motor is during.

## EMC

This component meets the requirements of the product standard EN60947-4-2 and is CE marked according to this standard.